

20



January
25 Cents
Canada 30c

Radio-Craft

HUGO GERNSBACK Editor

How to Make a
Radio
"Growler"

See Page 398

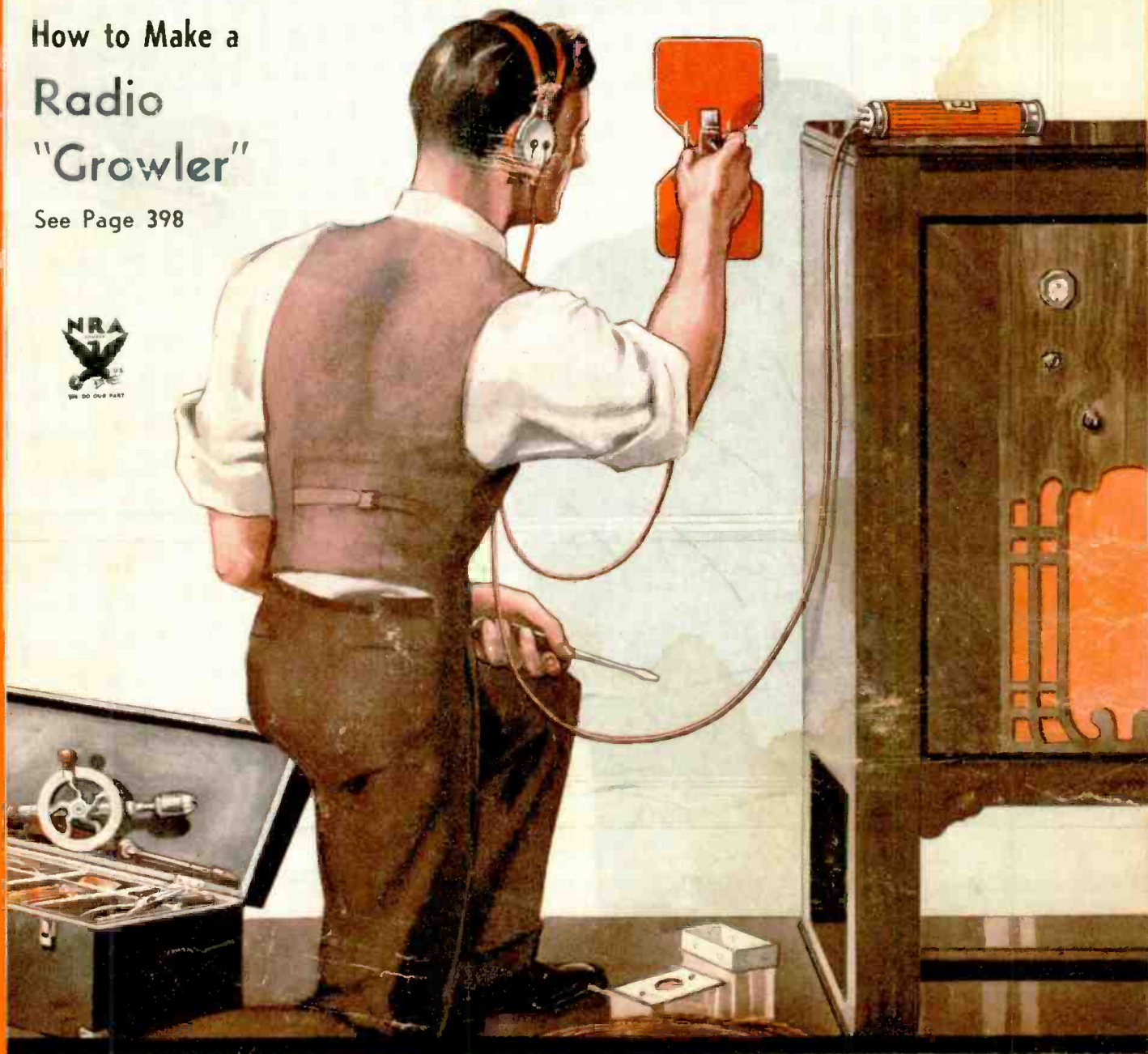

New Patents — A Neon-Type Meterless Tube Checker — All-Wave Sets
How to Make an Ultra-Modern Analyzer — Making a Diode Voltmeter

McMurdo  Silver's

MASTERPIECE, II

Now in the Antarctic with Byrd because two great eastern universities acclaimed it the most efficient all-wave receiver.

Now the preference of Broadcast Executives and technicians because, by their tests, it shows greater sensitivity and more perfect fidelity of tone on broadcast as well as foreign short wave reception.

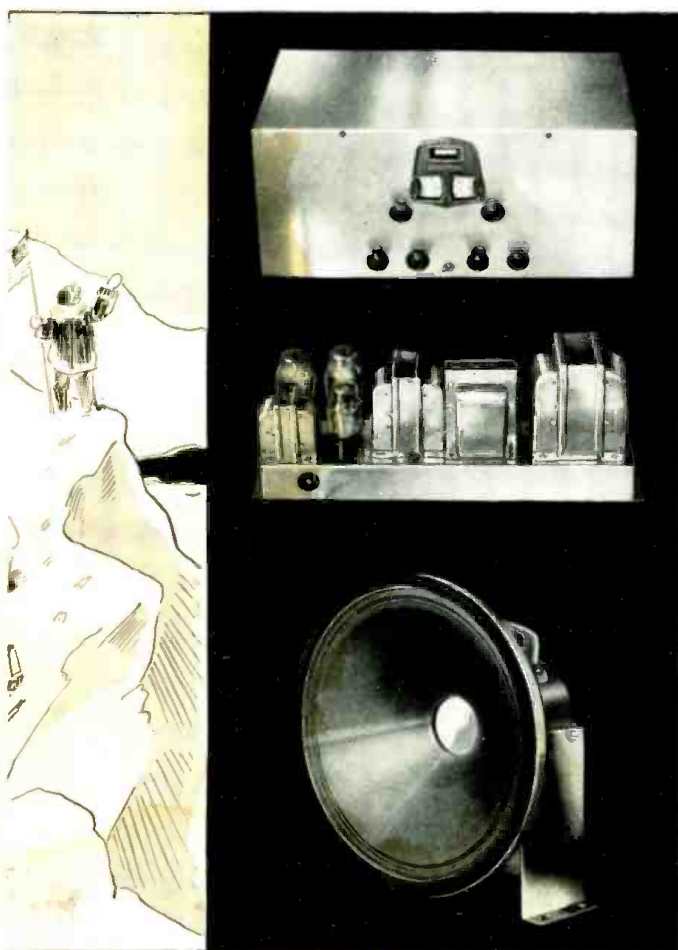

BRIEF SPECIFICATIONS

Wave length Range 10 to 570 meters or 520 to 30,000 kc. Four position wave change switch. (External unit extends range from 700 to 2000 meters.)

Tuned R.F. stage on both Broadcast and entire Short Wave range yet single dial tunes the receiver. Greatly improves signal-noise ratio on 12,000 mile reception.

Band-spread tuning on short waves. Makes short wave tuning actually easier than broadcast tuning.

3 air-tuned intermediate stages. Most accurate intermediate amplification ever developed.

Sensitivity better than 1/4 micro-volt absolute average. Interstation noise suppressor adjustable to exact location requirement.

Automatic volume control holds all stations 20 microvolts and up at constant volume to the ear.

Selectivity absolute 9 Kc. for Europe, better than U. S.

needs (21 Kc. wide 10,000 times down).

Fidelity perfect over 30 to 4,000 cycle audio range. Undistorted power output, 15 watts. Automatic and manual tone controls.

Special impregnation for tropical climates.

Built-in beat oscillator for easy finding of S. W. and weak broadcast stations.

Chromium plated steel shielding case eliminates need for cabinet.

Not only has my Masterpiece II been accorded the distinction and honor of serving Admiral Byrd in the Antarctic, but . . . it is also the preferred choice of Broadcast Executives and Technicians.

J. Kelley Smith, director of radiostation WBBM says, "I was particularly impressed with the excellent tone quality of the receiver, that seems to be practically flat from 30 cycles to upwards of 5000 cycles. This is not only important for excellence of tone quality in the broadcast band but even more so for clear, satisfying reception from foreign points on short wave broadcasts that might not be intelligible on a receiver with average tone quality, but which on your receiver are delivered clearly and distinctly."

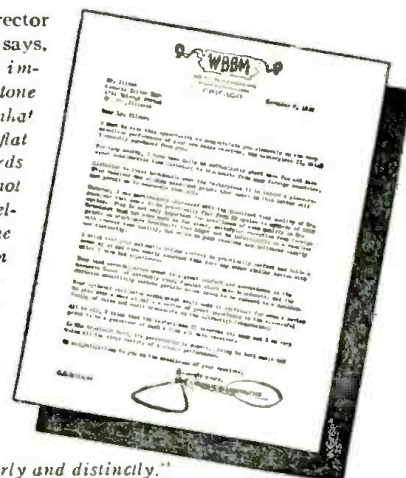

And R. B. Stephenson, Western Sales Manager of WBBM, KMOX, WCCO, WJSU, WKRC, WBT and WPG says, "As you know, I have been very enthusiastic about my present receiver, a very well known, custom-built, all-wave set. But, I must admit that in this comparative demonstration, you have entirely changed my mind. A surprising discovery also was the superb tone quality of your receiver. To my surprise, your receiver has much better definition, and a pure, liquid naturalness that makes all other receivers sound "boom-y" in comparison."

So, why should you accept less dependability in world-wide reception than Admiral Byrd demands? Why should you be content with less tone quality than such competent authorities as J. Kelley Smith and R. B. Stephenson consider necessary?

10 DAY TRIAL

Send for a Masterpiece II. Try it 10 full days. If for any reason you want to return it, you can have your money back instantly, without argument. It's just as simple as that. But, first send the coupon for the full detailed story of this great receiver designed especially for Admiral Byrd . . . and for you who are entitled to just as much.

McMurdo Silver, Inc., 1735 Belmont Ave., Chicago, U.S.A.
Send me full information on Masterpiece II.

Name

Street

Town State

McMURDO SILVER, INC.
1735 BELMONT AVENUE - - - CHICAGO, U. S. A.

RADIO-CRAFT is published monthly, on the fifth of the month preceding that of date; its subscription price is \$2.50 per year. (In Canada and foreign countries, \$3.00 a year to cover additional postage.) Entered at the postoffice at Mt. Morris, Ill., as second-class matter under the act of March 3, 1879.

Learn at Home to Make More Money

**I'll train You Quickly for Radio's
GOOD Spare Time and Full Time Jobs**



J. E. SMITH, President
National Radio Institute

The man who has directed the Home-Study Training of more men for the Radio industry than any other man in America.



BROADCASTING STATIONS offer many fascinating, interesting, and good pay jobs to the trained Radio man.

Why slave your life away in a no-future job? Why skimp, why scrape, trying to pay your bills? I'll train you quickly for the live-wire field—the field with a future—**RADIO**. \$40, \$60, \$75 a week—that's what many Radio Experts make. \$5, \$10, \$15 a week extra money—that's what many of my students make in their spare time shortly after enrolling. My free book tells you about Radio's spare-time and full-time opportunities—about my tested training—about my students and graduates—what they are doing and making. Get this book. Be a Radio Expert. The Radio field is big enough to absorb many more properly trained men.

I'll train you for jobs like these

Spare-time and full-time Radio Servicing, Operating, Broadcast, Aircraft Radio, Commercial Land, Ship and Television stations, a Radio service business of your own. I'll train you for these and other good jobs in the manufacture, sale and service of Radio, Sound and Television apparatus. My **FREE** book tells you about the many money-making opportunities in Radio.

Save—learn at home in your spare time

You don't have to leave home and spend \$500 to \$1,000 to study Radio. I'll train you quickly and inexpensively right in your own home and in your spare time for a good Radio job. You don't need a high school or college education. Many of my successful graduates didn't even finish grade school. My amazingly practical 50-50 method of training—half with lessons, half with Radio equipment—gives you broad practical experience—makes learning at home easy, fascinating, practical and rapid.

(Continued on other side)



LOUD SPEAKER installation and service work is another growing, money-making field for trained Radio men.

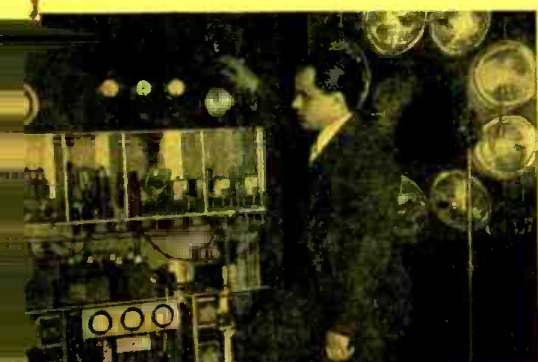

TELEVISION, the coming field of great opportunities, is covered in my Course.

PLACE
ONE
CENT
STAMP
HERE

MR. J. E. SMITH, President

NATIONAL RADIO INSTITUTE

16th and U Streets, N. W.

Dept. 4AX

WASHINGTON, D. C.

Many Radio Experts make \$40, \$60, \$75 a week

(Continued from other side)

Many make \$5, \$10, \$15 a week Extra in spare time almost at once

My book shows how my special training, instruction material, plans, ideas and my twenty years experience training men for Radio careers has helped many students make \$200 to \$1,000 a year quickly in their spare time. My Course is famous as "the one that pays for itself."

Your money back if not satisfied

I'm so sure you will be satisfied with my training that I agree in writing to refund every penny of your money if you are not entirely satisfied with my Lessons and Instruction Service when you finish.

Find out what Radio offers you

Act today. Mail the post card below. My 64-page book will be sent free to any ambitious fellow over 15 years of age. It tells about Radio's opportunities—explains the eighteen star features of my Course—shows letters of what others are doing and making. There is no obligation. Put a one cent stamp on the post card and mail it now.

**J. E. SMITH, President
NATIONAL RADIO INSTITUTE
WASHINGTON, D. C.**



*Find Out
What Radio
Offers You*
MAIL THIS NOW

Mr. J. E. SMITH, *President*
National Radio Institute, Dept. 4AX
Washington, D. C.

Dear Mr. Smith: Without obligating me, send your book which points out the spare-time and full-time job opportunities in Radio and explains your amazingly practical 50-50 method of training men quickly and inexpensively at home in their spare time to be Radio Experts. *(Please print plainly.)*

Name.....Age.....

Address.....

City.....State.....



SET SERVICING has paid many N. R. I. men \$200 to \$1,000 a year for their spare time. Full-time men make as much as \$40, \$50, \$65 a week.

Some Other Jobs N.R.I. Trains Men For

- Broadcasting engineer
- Operator in broadcasting station
- Maintenance man in broadcasting station
- Superintendent in Radio factory
- Engineer in Radio factory
- Inspector in Radio factory
- Radio operator on ships
- Sales manager for Radio stores
- Service manager for Radio stores
- Buyer for Radio stores
- Government Radio electrician
- Government Radio supervisor
- Operator of government Radio beacon stations
- Aircraft Radio operator
- Aircraft Radio dispatcher
- Television engineer
- Television transmitter operator
- Television maintenance man
- Engineer in commercial Radio land stations
- Installation man on loud speaker systems
- Serviceman on loud speaker systems
- Automobile Radio installation and service man
- Police Radio transmitter operator
- Police Radio receiver serviceman

Here's Proof

\$50 to \$75 a week

 "The National Radio Institute put me in a position to make more money than I ever made in good times. I am in the Radio service business for myself, where it is possible for me to make from \$50 to \$75 a week. Service work has increased because people, who in normal times would buy a new 'pepped up'—BERNARD COSTA, 150 Franklin St., Brooklyn, N. Y.

"Made \$6,000 in 2 years"

 "Soon after the depression started, I found myself without a job, but I was well protected with N. R. I. training. I swung right to full-time Radio servicing and I have made over \$6,000 in a little over two years."—WM. SPARTY, TIVENT, Sparty Radio Service, 93 Broadway, Newark, N. J.

"\$500 a Year in Spare Time"

 "Although doing spare-time Radio work only, I have averaged about \$500 a year extra in addition to my regular income. Full-time Radio work would net me many times that amount."—EDW. H. FAWCETT, Slough Road, Ladner, B. C., Canada.

"Good Position, Good Pay"

 "I am Chief Operator at Radio Station WSMK. This is a good position, with good pay. I have advanced in Radio right along. I recommend N. R. I. to anyone who wants to be successful in Radio."—JOHN HAJDUK, JR., 3 Broxey Apts., Southern Hills, Dayton, Ohio.

LEARN RADIO IN 10 WEEKS!

PAY FOR YOUR TRAINING AFTER YOU GRADUATE

I am making an offer that no other school has dared to do. I'll take you here in my shops and give you this training and you pay your tuition after you have graduated. Two months after you complete my course you make your first payment, and then you have ten months to complete your payments. There are no strings to this offer. I know a lot of honest fellows haven't got a lot of money these days, but still want to prepare themselves for a real job so they won't have to worry about hard times or lay offs.

I've got enough confidence in these fellows and in my training to give them the training they need and pay me back after they have their training.

If you who read this advertisement are really interested in your future here is the chance of a life time. Mail the coupon today and I'll give you all the facts.

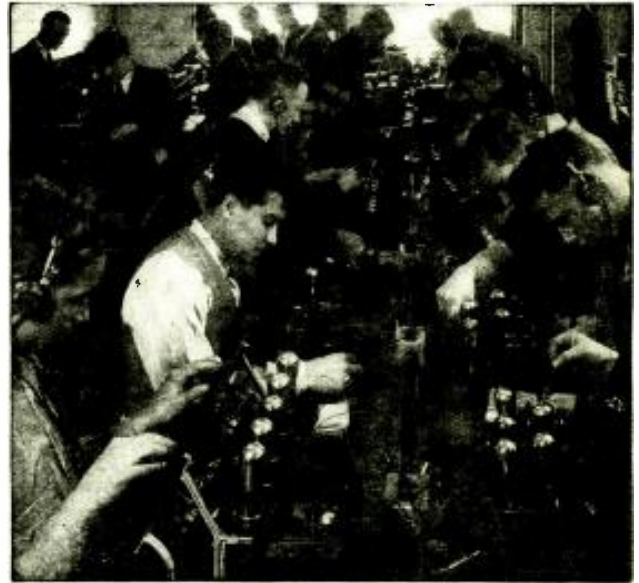

A scene in the big, busy Radio Shops at Coyne. Here you see fellows working on real Radios—not reading about them from books or lessons. This is THE way to prepare for the big-money field of Radio!

TELEVISION *and* TALKING PICTURES

Television is already here! Soon there'll be a demand for THOUSANDS of TELEVISION EXPERTS! The man who learns Television now can have a great future in this great new field. Get in on the ground-floor of this amazing new Radio development! Come to COYNE and learn Television on the very latest, newest Television equipment. Talking Picture and Public Address Systems offer opportunities to the Trained Radio Man. Here is a great new Radio field just beginning to grow! Prepare NOW for these wonderful opportunities! Learn Radio Sound Work at Coyne on actual Talking Picture and Sound Reproduction equipment.

PREPARE NOW and be ready for Radio's many opportunities

Forget pay-cuts—lay-offs—unemployment! Don't be tied down to an untrained man's future. You NEED TRAINING IN A FAST-GROWING MONEY-MAKING TRADE. Here's your chance of a lifetime to get it! Hundreds of opportunities now open in Radio. My sensational offer, explained below, makes it possible for you to START AT ONCE!

The right way to learn Radio is the Coyne way—not by books, but by actual, practical work on actual Radio, Television and Sound equipment. Here at Coyne you'll service and operate scores of modern Radio receivers, huge Broadcasting equipment, late type Television apparatus, Talking Picture machines, Code transmitters and receivers, etc. In 10 weeks you can step into a REAL JOB, leading to a salary of \$50 a week and UP!

ALL PRACTICAL WORK At COYNE in Chicago

ALL ACTUAL, PRACTICAL WORK. You build radio sets, install and service them. You actually operate great Broadcasting equipment. You construct Television Receiving Sets and actually transmit your own Television programs over our modern Television equipment. You work on real Talking Picture

machines and Sound equipment. You learn Wireless Operating on actual Code Practice apparatus. We don't waste time on useless theory. We give you the practical training you'll need—in 10 short, pleasant weeks.

MANY EARN WHILE LEARNING

You get Free Employment Service for Life. And don't let lack of money stop you. Many of our students make all or a good part of their living expenses while going to school and if you should need this help just write to me. Coyne is 33 years old. Coyne Training is tested—proven beyond all doubt. You can find out everything absolutely free. Just mail coupon for my big free book!

H. C. LEWIS, Pres. RADIO DIVISION Founded 1899
COYNE ELECTRICAL SCHOOL
500 S. Paulina St., Dept. 14-8H Chicago, Ill.

Mail Coupon Today for All the Facts

H. C. LEWIS, President
Radio Division, Coyne Electrical School
500 S. Paulina St., Dept. 14-8H Chicago, Ill.

Dear Mr. Lewis: Send me your big FREE Book; details of your FREE Employment Service; and tell me all about your special offer of allowing me to pay for training on easy monthly terms after graduation.

Name.....

Address.....

City.....State.....



HUGO GERNSBACK, Editor-in-Chief

C. W. PALMER
Associate Editor

R. D. WASHBURNE
Technical Editor



CONTENTS OF THE JANUARY, 1934, ISSUE

VOLUME V NUMBER 7

Editorial: All-Wave Sets.....Hugo Gernsback	389
The Radio Month in Review.....	390
Recent Radio Developments—Illustrated	392
"Dialing" 42 World-Wide Programs	393
Latest in Radio	394
International Radio Review	397
How to Make a Radio Growler.....Francis M. Beck	398
A Super-Power and -Quality P. A. System Part II	400
The 20th Birthday of a Radio School..Joseph Kaufman	401
Radio Short-Cuts	402
Readers' Department	403
How to Make a Beginner's Pianotron Francis R. Harris	404
How to Make a Modern Car Radio Set Part II	406
Servicing the "Talkies," Part III.Aaron Nadell	408
How to Make Your Own Transformers and Chokes Part II	409
How to Make and Operate an Ultra-Modern Set Analyzer	410
New Patents	411
Making a Diode Multimeter.....Bert Bethiany, Jr.	412
A Neon-Type, Meterless Checker.....C. H. Hockner	413
RADIO SERVICE DATA SHEETS:	
No. 105—Midwest Model 16-34 Super-DeLuxe 16-Tube All-Wave Superheterodyne	414
No. 106—Kadette Models A and B, 5-Tube A.C.- D.C. Superheterodyne	415
Operating Notes	416
RADIO-CRAFT'S Information Bureau	418
Book Review	441

IN OUR NEXT FEW ISSUES:

A BEGINNER'S SHORT-WAVE SET. At last we can offer to the experimenter who wishes to delve into the field of short-wave radio reception a simple little "battery" set made up in "breadboard" style. The design is so easy to build that almost anyone can construct it in an hour or so. The instrument will serve as a nucleus for more advanced designs to be described in subsequent issues.

A VOICE-OPERATED CONTROL. Electronic devices are now found in every field of endeavor. One of the most interesting from the standpoint of the experimenter is that of electro-dynamics, or the electrical control of mechanical devices. The author describes an easily-built unit that may be constructed at very low cost; and which may be useful, or merely entertaining—depending upon the particular use to which it is put. A word whispered into its microphone actuates the "control."

RADIO-CRAFT is published monthly, on the fifth of the month preceding that of date; its subscription price is \$2.50 per year. (In Canada and foreign countries, \$3.00 a year to cover additional postage.) Entered at the post office at Mt. Morris, Ill., as second-class matter under the act of March 3, 1879.

Text and illustrations of this magazine are copyright and must not be reproduced without permission of the copyright owners. We are also agents for WONDER STORIES and EVERYDAY SCIENCE AND MECHANICS. Subscription to these magazines may be taken in combination with RADIO-CRAFT at reduced Club rates. Write for information.

Copyright 1933. Continental Publications, Inc.

HUGO GERNSBACK, President

I. S. MANHEIMER, Secretary

Published by Continental Publications, Inc. Publication office: 404 N. Wesley Ave., Mount Morris, Illinois. Editorial and Advertising Office: 96-98 Park Place, New York City. Chicago Advertising Office: L. F. McClure, 919 North Michigan Avenue, Chicago, Ill. Western Advertising Office: Loyd B. Chappell, 511 So. Alexandria St., Los Angeles, Calif.

London Agent: Hachette & Cie., 3 La Belle Sauvage, Ludgate Hill, E.C. 4
Paris Agent: Hachette & Cie., 111 Rue Reaumur
Australian Agent: McGills Agency
179 Elizabeth St., Melbourne



\$3.50

Reg. List Price

400 Pages

Over 2,000 Illustrations

9 x 12 Inches

Flexible, Looseleaf
Leatherette Cover

There's plenty of Servicing Material

in the NEW 1934 Manual

THE necessity of GERNSBACK Manuals in the radio field has been shown by the fact that the total sales of the first three OFFICIAL RADIO SERVICE MANUALS, including the new CONSOLIDATED EDITION, now exceed 80,000 copies. Radio Service Men and others engaged in various branches of radio know the importance of such books, and how they must depend upon them for reliable information. Whether for public-address work, tube information or a circuit diagram, the material needed is certain to be found in one of the OFFICIAL RADIO SERVICE MANUALS.

In preparing this new edition many of the outstanding problems of the Service Men have been considered—methods of servicing, the new equipment constantly needed to cope with new tubes and sets, and the other fields of radio, such as public-address systems, short waves, auto radio and others.

The illustrations in the 1934 Manual are more explicit than before; inasmuch as the diagrams are not limited to the schematic circuit, but other illustrations show the parts layout, positions of trimmers, neutralizers, etc. There are hundreds of new circuits included, and not one from any previous editions of the manuals has been repeated. *This we unconditionally guarantee.*

As in previous years, the 1934 Manual also includes a FREE QUESTION AND ANSWER SERVICE. In each book will be found 25 coupons, which entitle you to free consultation on any radio service topic. These coupons give you a complete mail service—questions on servicing and operating any set or circuit are answered promptly and accurately by the editors. Remember that, at the regular rate of 25c per question which is usually charged by radio magazines, this service alone is worth \$6.00. And for the Manual, we charge only \$3.50.

It is quite evident that the 1934 Edition of the OFFICIAL RADIO SERVICE MANUAL is a decided improvement over previous volumes.

ORDER YOUR COPIES NOW

It is important to every Radio Service Man and Dealer to get his copy of the 1934 OFFICIAL RADIO SERVICE MANUAL now. The new book will prove itself to be invaluable as those volumes of previous years.

No need to delay sending us your order—the 1934 MANUAL, like its predecessors, is a necessity in your business. We strongly advise you to order your copy today.

GERNSBACK PUBLICATIONS, INC.
96-98 Park Place New York, N. Y.

Contents of the 1934 Manual in Brief

- Diagrams and service notes, more complete than ever before in any MANUAL. Not merely the schematic hook-ups will be found, but chassis drawings showing parts layouts, positions of trimmers, neutralizers, etc.
- Voltage readings for practically all sets, as an aid in checking tubes and wiring.
- All values of intermediate-frequency transformers used in superheterodynes, with the manufacturers' own suggestions as to correct balancing.
- Detailed trouble-shooting suggestions and procedure as outlined by the manufacturers' own engineers—in other words, authentic "dope" right from headquarters.
- Values of all parts indicated directly on all diagrams.
- Section for reference to A.C.-D.C. cigarbox midsets.
- Section for reference to public-address amplifiers.
- Section for reference to short-wave receivers.
- Section for reference to remote-control systems.
- A complete compilation of radio tube data, covering both the old and the many new types.
- Section devoted to test equipment, analyzers, etc., with full diagrams and other valuable information.
- A complete list of American broadcast stations with their frequencies in kilocycles; extremely useful in calibrating and checking test oscillators and in calibrating receivers.
- Free Question and Answer Service, the same as in our last two Manuals.
- No theory; only service information in quickly accessible form.
- Absolutely no duplication of any diagrams; nothing that appeared in any of the previous Manuals will appear in the 1934 MANUAL. This we unconditionally guarantee.
- A handy, easily-consulted master index making it easy for you to find almost anything pertaining to your service problem instantly. This index includes all the diagrams published in all the previous GERNSBACK Manuals, as well as the 1934 diagrams. A big convenience and time saver!

Clip—Mail This Coupon Today

GERNSBACK PUBLICATIONS, Inc.
96-98 Park Place, New York, N. Y.

Gentlemen: Enclosed you will find my remittance of \$3.50 for which you are to send me, Postage Prepaid, One Copy of the 1934 OFFICIAL RADIO SERVICE MANUAL. [Send remittance by check or money order; or register letter if it contains cash, currency or unused U. S. Postage stamps.]

Name

Address

City State

RC-134

The Radio-Craft Library Series covers accurately every branch of Radio—and thoroughly, too

Presented on this page are the new books of the RADIO-CRAFT LIBRARY—the most complete and authentic set of volumes treating individually, important divisions of radio. Each book has been designed to give radio men the opportunity to specialize in one or more of the popular branches of the industry. The material contained

in these books will increase your knowledge; you will find them a real help in your work and they will contribute to your money earning capacity. Read these books during your spare time at home.

The authors of these books are well-known to everybody. Each one is an expert radio man; an authority on the subject—each is thoroughly

familiar with the field which he represents.

This is perhaps the first real opportunity that you have ever had to build a radio library of books that are authentic, right-up-to-the-minute and written so that they are easily digested and clearly understood. Mail coupon below for your books.

TO THE RIGHT WILL BE FOUND A SHORT RESUME OF EACH BOOK



Book No. 1

Radio Set Analyzers

And How To Use Them

With Full Instructions and Descriptions of Set Analyzers, Tube Checkers, Oscillators, Etc.

By L. VAN DER MEL

This book explains thoroughly the operation of set analyzers, tube checkers, oscillators and other testing equipment. For every radio man this book is extremely helpful. It covers every phase of testing and gives you valuable short cuts; completely illustrated with photographs and diagrams to facilitate the use of modern testers. Recently reprinted.

Book No. 2

Modern Vacuum Tubes

And How They Work

With complete Technical Data on All Standard and Many Special Tubes

By ROBERT HERTZBERG

MODERN VACUUM TUBES describes the fundamental electron theory which is the basis of all vacuum tube operation, and goes progressively from the simplest two-element tubes right up to the latest pentodes and thyatrons. It is written in clear, simple language and is devoid of the mathematics which is usually so confusing. Valuable reference charts and characteristic curves of standard and special tubes are to be found, also diagrams of sockets and pin connections.

Book No. 3

The Superheterodyne Book

All About Superheterodynes

How They Work, How to Build and How to Service Them

By CLYDE FITCH

There is no more fascinating a subject in the large array of radio circuits than the famous superheterodyne circuit. Whether you are a Service Man or experimenter, first-hand knowledge about the construction of superheterodyne receivers is very important. The book on Superheterodynes gives underlying principles of their construction, right from the very first set made.

Book No. 4

Modern Radio Hook-Ups

The Best Radio Circuits

A Complete Compendium of the Most Important Experimental and Custombuilt Receivers

By R. D. WASHBURNE

It is fascinating to the experimenter, or even to the up-to-date Service Man, to take a commercial set and to change it into one using a famous hookup that is not found in any manufactured set. Many excellent circuits have never been commercialized, but limited only to home set builders. Thousands of these popular circuits have been requested from time to time, and in this book we have included over 150 circuits, which include the famous Perlitone, Cash-Flow A.C.-D.C. Set and others.

Book No. 5

How to Become a Radio Service Man

How to Get Started and How to Make Money in Radio Servicing

By LOUIS MARTIN

The ambition of many men in radio today is to become a first-grade Service Man. It is not as difficult as one might believe, but it cannot be done in a few short months. Following very carefully the advice of Mr. Martin, who has dealt with the problems of thousands of Service Men, this book deals very carefully with the essential stages in the preparation for qualifying as a Service Man.

Book No. 6

Bringing Electric Sets Up to Date

With Pentodes, Multi-Mus. Dynamic Speakers—Complete Information How to Modernize A. C., D. C. and Battery Operated Receivers

By CLIFFORD E. DENTON

In this country there are over ten million electrically operated receivers that could be modernized—by placing in them new type tubes, new speaker equipment. This other modern improvements. This business of improving old sets can go to the experimenters and Service Men if they will quickly jump into action.

Book No. 7

Radio Kinks and Wrinkles

For Service Men and Experimenters

A Complete Compendium on the Latest Radio Short-Cuts and Money-Savers

By C. W. PALMER

It often becomes necessary for experimenters and Service Men to call upon their memory for some short cut or radio wrinkle that will solve a problem quickly. In business, "short cuts" mean time and money saved, and to the Service Man "time saved" means money earned.

Book No. 8

Radio Questions and Answers

A Selection of the Most Important of 5,000 Questions Submitted by Radio Men During the Course of One Year

By R. D. WASHBURNE

There have been collected a wide variety of questions which have come into our editorial offices during the past two years, and only those whose answers would benefit the majority of men engaged in radio have been incorporated in this amazing question and answer book. A tremendously long list of topics is treated.

Book No. 9

Automobile Radio and Servicing

A Complete Treatise on the Subject Covering All Phases from Installing to Servicing and Maintenance

By LOUIS MARTIN

Automobile radios are up and coming, and someone has to service them properly. It therefore behooves you to read this immensely important new book on the art of Automobile Radio. The book is concise, and full of illustrations, photographs, diagrams and hookups.

A few of the really interesting chapters: Introduction; Automobile Radio Installations; Complete Descriptions of Commercial Automotive Receivers; Servicing Automotive Receivers; The Ignition System; General Service Considerations; Effects of Temperature on Power Supply; Conclusion.

Book No. 10

Home Recording and All About It

A Complete Treatise on Instantaneous Recordings, Microphones, Recorders, Amplifiers, Commercial Machines, Servicing, etc.

By GEORGE J. SALIBA

If there is one subject that is fascinating to every radio man, it is that of Home Recording. Of course, this volume is not all on "Home" recording, but the information contained therein is important to commercial radio men, studio operators, engineers and other interested in this phase of radio.

The art of recording and reproducing broadcast selections is becoming more important every day to radio men, experimenters and Service Men. Equipping dance halls, auditoriums, churches, restaurants and homes with public address systems and amplifiers brings many extra dollars and often an excellent income.

Book No. 11

Point-to-Point Resistance Measurements

The Modern Method of Servicing Radio Receivers

By CLIFFORD E. DENTON

Of the difficult problems which Service Men face today when repairing receivers, the greatest is that of replacing proper resistance values in sets. This task becomes more difficult when the values of resistors are unknown, and manufacturers of many standard sets do not give this information to Service Men. In this new book, radio men will find the information needed to quickly place a receiver in normal operating condition. This book cuts in half the time usually required to adjust the average set. Sufficient space has been devoted to elementary problems and the theory of electricity as it is applied to resistance measurements so that the Service Man will have a comprehensive idea as to how to overcome this problem.

Below you will find a partial list of the contents which will appear in this new book: INTRODUCTION; Advantages of Resistance Measurement Method of Servicing for Radio Work; Basic Principles; Methods of Resistance Measurement; Resistors in Radio Receivers and Amplifiers; Point-to-Point Resistance Measurements; Servicing Radio Sets using Ohmmeter; Resistance Measurements using Modern Tester; Routine Testing where Circuit Diagram is Not Available and where Resistances are Known; Routine Testing where Circuit Diagram is Unknown and where Resistances are Unknown; The Relation of Voltage Testing Methods to Resistance Measurement; APPENDIX: Resistance Charts etc.

ALL BOOKS UNIFORM

The books in the new RADIO-CRAFT LIBRARY are all strictly up-to-date, and written by men who know their subjects. The volumes are all uniform size, 6x9 inches, and contain on an average of 50 to 120 illustrations. Each book is printed on fine book paper and no expense has been spared to make it an outstanding value, for its editorial contents as well as from the mechanical standpoint.

Big Discount to You

In order to make it possible for everyone to buy these books, the fifty (50) cent price has been made uniform for all volumes. You can buy these books separately, but you should take advantage of our special offer.

When Five (5) Books or More Are Ordered

Deduct 20% from Your Remittance

Simply fill in the coupon at left, and mail it to us together with your remittance. Checks, stamps or money orders accepted.

Clip Coupon and Mail Today!

GERNSBACK PUBLICATIONS, INC., 96-98 Park Place, New York, N. Y.

I have circled below the numbers of books in the RADIO-CRAFT LIBRARY, which you are to send me, and have deducted 20% for ordering five (5) books or more. I have included my remittance in full, at the price of 50c each, when less than five books are ordered.

The amount of my remittance is.....(Stamps, checks or money orders accepted.)
Circle numbers wanted: 1 2 3 4 5 6 7 8 9 10 11

Name Address

City State RC-134



"Takes the Resistance Out of Radio"

Editorial Offices: 96-98 Park Place, New York, N. Y.

HUGO GERNSBACK, Editor

Vol. V., No. 7, January, 1934

ALL-WAVE SETS

An Editorial by HUGO GERNSBACK

THE radio industry is now in the midst of another new cycle, while a new series of radio sets is being developed under the name of "all-wave" sets. To be sure, the design of all-wave receivers is nothing particularly new, but the point is that practically all of the large manufacturers are now engaged in turning out sets of this type, which is indeed a departure from the former practice. Up to this year, the so-called all-wave sets were a misnomer because such sets only tuned down to the police band of about 170 meters and up to 600 meters. It should be particularly noted that the great and fundamental difference between so-called "all-wave" sets of 1931-'32 and the present sets is that the older models were *converters*, a highly inefficient type as compared to the present *straight* type all-wave sets. The newer all-wave models which are now coming on the market are intended to cover the entire short-wave spectrum from 15 meters up to 200 meters, *plus* the broadcast range from 200 to 550 meters.

Fundamentally, there is nothing technically new or exciting in the design of these sets except in the coils and switching arrangements used to tune down to the lower-wave ranges. In practically all such sets, with few exceptions, the changing of wavelength is done by means of a switching arrangement. If we may venture the criticism, we might say that up to the present time no perfect switching arrangement has been developed. Practically all of these sets have the short-wave coils so bunched together that one coil reacts upon the other. It is a well-known fact that a coil, even if it is not connected into the circuit, if it comes within about two inches from the "live" coil, will affect the latter and cut-down its efficiency.

For that reason, the short-wave expert will never use a switching arrangement under any circumstances; he will, instead, stick to the use of orthodox plug-in coils. He has found from experience that only plug-in coils give—everything being equal—maximum results. And for that reason, the short-wave enthusiast will not be likely to have a set which has a switching arrangement.

There are some exceptions to this rule, as there are one or two circuits where a switching arrangement can be used since the losses, due to exceedingly powerful regeneration, do not cut down the efficiency appreciably. But it is also true that most commercial sets could not use these circuits; and the attendant losses in the switching system are usually high.

It should be noted that this criticism is only from the standpoint of the short-wave expert. The average man who is out for distance and for the reception of foreign stations is not unduly bothered by 10 or 15% lower efficiency. He does not wish to be annoyed with plug-in coils which, to him, are entirely too technical and too fussy. He wants to get results and wants to get them quick, and for him the switching-coil arrangement is the best solution. Then, it must also be said in favor of the switching-coil systems, that given sufficient

amplification (which is available in most of the modern all-wave sets) the little losses from the switching-coil arrangement do not cut much ice after all. The owner wishes to get reception and there is no question that the modern all-wave set gets this reception, often uncomfortably loud. That is, of course, providing the set is well designed otherwise, has a sufficient amount of amplification and is well engineered from the short-wave standpoint. And, it might be said that set manufacturers are rapidly learning how to turn out creditable sets which pull in overseas stations regularly.

One more point about these sets is often overlooked. If you are in the city or even a suburb where there is man-made static, where there are many automobiles, etc., the usual type of aerial is totally unsuited for the all-wave set. It simply will not do for short wavelengths—for, with the usual aerial, all that you will get are noise and disappointment. Some of the manufacturers who are putting out these sets are aware of this fact and point out the remedy in their literature. Others, and there are a good many, do not seem to bother about the results which their customers will get, and refrain from giving any information.

Now, it is a fact that the ordinary aerial will pick up entirely too much noise on the shorter wavelengths—noise which will affect practically all reception unless you operate the set in an isolated neighborhood, far from electrical appliances, telephone lines, and automobiles on the road.

What is vitally necessary with these all-wave sets is a *transposition lead-in*, and a twin half-wave aerial with wires high above the street level and stretching in opposite directions. A number of such aerials are now on the market and are the only effective answer to the short-wave noise problem. The transposition lead-in aerial usually is composed of two wires which, running over flat insulators, criss-cross each other down to the aerial coupling coil of the set. Other safeguards must be taken such as the use of a shielded ground wire, etc., and the entire aerial installation must be of such a nature that it does not allow the pick up of extraneous, man-made static. With a well-engineered transposition aerial, the reception on the all-wave sets should be good no matter where located, and excellent reception should be realized practically all of the time.

Then, of course, the man who owns an all-wave receiver should not expect to pull in the foreign stations at any and all times. The short-wave magazines and log books publish regular schedules showing at which times of the day reception, in America, of foreign stations will be most suitable. Thus, in eastern United States, the western European stations come in best in the afternoon. Australian stations can only be received well in the early morning hours, from 4 o'clock to 8 o'clock, A.M. Then, of course, the owner of one of these new sets should know that there is such a thing as time difference. He should know that when Big Ben strikes the Midnight hour in London, it is five hours earlier, that is 7 o'clock in New York, etc.

The RADIO MONTH in

BROADCAST CHAIN BUSINESS IMPROVES



M. H. AYLESWORTH
Whose company has moved to Radio City.

"BROADCAST advertising is an index to business conditions" declared M. H. Aylesworth, widely-heralded president of the NBC, in a recent interview with the press. And when the head of so prominent a radio company makes a statement about business, it is well for Mr. Average Man to "prick up his ears" and listen.

President Aylesworth continued to say that in times like the present, broadcast advertising is a "barometer which indicates the state of mind of the advertiser, the director of commerce and industry.

"If manufacturers and business men, many of whom have cut their advertising appropriations to the bone during the past few years, are making a general move toward the resumption of their normal advertising campaigns, then there must be a general increase in confidence."

And as if to reiterate his statements, comes a report that 6 stations connected with the NBC chain have just increased their rates for commercial programs during the evening hours. These stations with their new and old rates are as follows:

Station	Location	New Rate per hr.	Old Rate per hr.
WEEL	Boston	\$400	\$250
WFAA	Dallas	300	190
WJR	Detroit	500	340
WKBF	Indianapolis	190	...
WSB	Atlanta	300	190
WSM	Nashville	300	190

The increase in the rates of these stations are justified, according to statements made by NBC, because of increases in the power of these stations since the rates were originally set;

which resulted in a large expansion in the number of listeners.

This is pleasant knowledge to the long-established chains but it isn't going to do one chain any good—we mean none other than the Ed Wynn chain which we forecast last month was headed for the ash can, where it now reposes.

THE 1020 KC. CLEAR CHANNEL CASE

AS OUR good friend Schnozzle Durante would say — "Flash; Washington, D.C."—The Federal Radio Commission gave the Westinghouse Electric and Manufacturing Company permission, recently, to move station KYW from Chicago to Philadelphia.

This decision brought to a close the long drawn-out case regarding the 1020 kc. "clear channel." Numerous applications were sent to the much abused F.R.C. after they ordered this channel to be moved from the midwest to the east, more than a year ago.

The Westinghouse people intend to build a 10 kw. transmitter near Philadelphia. This station will use an antenna system that has directive properties, so that interference with New Yorkers and residents of Baltimore will be minimized.

This change of location for popular KYW will be sad news for radio fans of the World Fair City, who have become used to the fine programs that have been transmitted from it. Let's hope the Quakers will be equally appreciative.

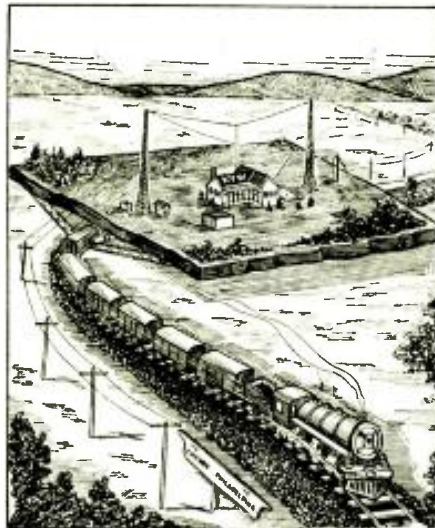

STATION KYW
Good-bye, Chi— Hello, Philly!

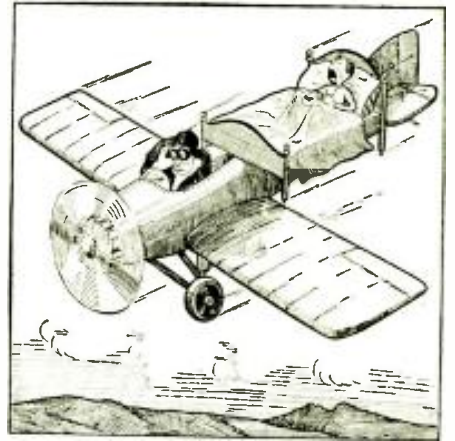

DOC RADIO
"He picked up his bed and . . ." flew.

AMATEUR TO THE RESCUE

MANY tales of heroism and public service have been told about amateur operators who have offered their unique communication networks in time of need. Now, comes Ed. Stevens, another ham, living in Seattle, Wash., who is adding his laurels to the "hall of fame."

The story is that friend Ed. was "talking" to the operator at Aiaktalik on Kodiak Island, off the coast of Alaska, and heard of a sick five year old boy.

Ed. asked for the symptoms and passed them on to a Seattle medico who diagnosed peritonitis, advising that the boy be rushed to the nearest hospital—Anchorage, Alaska.

Aiaktalik was unable to "raise" Anchorage by radio, so Ed. proceeded to do tricks with his station and got a message to the army radio at Seattle, which passed it on to Anchorage, whence an airplane was dispatched to pick up the youngster with the pain in his "tummy."

THE WAVELENGTH ALLOTMENT "BUG-A-BOO"

NOW that the North American radio conference has fizzled out, with nothing accomplished except a pleasant round trip vacation for the lucky (or unlucky—as you wish) representatives to Mexico City in a special train, some of the members of the Brain Trust are getting more serious about the radio broadcasting situa-

REVIEW

Radio is now such a vast and diversified art it has become necessary to make a general survey of important monthly developments throughout the field. RADIO-CRAFT analyzes these developments, and presents here a review of those items which are of interest to all.



CONFERENCE REPRESENTATIVES
A fine vacation was enjoyed by all!

tion and are pushing harder than ever for a New Deal in radio.

As a result of this conference the genial boss of the Federal Radio Commission, Harold F. Lafount has recommended that the number of 50 kw. stations be increased from 20 to 40, just double the previous number. This extension in power was sought by the bright-brained heads of a number of stations a few years ago, but they were cold-shouldered out of the idea by a lack of encouragement from the F.R.C. and by the increasing seriousness of the economic situation.

However, the editor wonders if the station owners now will be as anxious to spend those thousands of dollars for super-power stations as they were several years ago when they invaded the portals of the F.R.C. clamoring for more power!

Another result of the Conference is the threat of Mexican stations to increase their power. This is a serious situation to many of the larger broadcasters in the U. S. as these Mexicans, perched right on one of our fences, transmit on the same frequencies as those allotted as "clear channels" by Uncle Sam and the Mexicans are not nearly as hard-boiled about frequency adherence as the F.R.C. Result—"birdie whistles" in sets tuned to that frequency.

The recent conference over the pond (Amsterdam, Holland) to settle questions raised about the decisions of the Lucerne conference of the *Union Internationale de Radiodiffusion* met with equal success in failing to iron out differences of opinion—Europe's headache.

POLICE MOTORCYCLE RADIO SETS

IT IS interesting to note that after two years of research, Harley-Davidson, well known maker of motor-bikes has introduced a radio set for use on police motorcycles.

The cops' motorcycle radio is a 7 tube T.R.F. set mounted on a shelf behind the driver, with a magnetic speaker fastened between the handle bars.

The set is mounted entirely on the cycle—a side car for the "chief" can be added or removed without disturbing the installation. The aerial for the set is a flat strip of metal under the foot rest.

The use of motorcycles equipped with receivers in addition to the radio squad cars should prove an improvement over existing methods—as efficient as they are—due to the superior speed and maneuverability (many motorists will shed a tear at recollections, not so fond, to this effect) of the motorcycle.

In answer to our inquiries to the above-mentioned company, the following information is vouchsafed: "At the present time, there are between 175 and 200 radio equipped police motorcycles. Many more would be in use were it not for the fact that police departments generally throughout the Nation lack funds with which to make purchases."

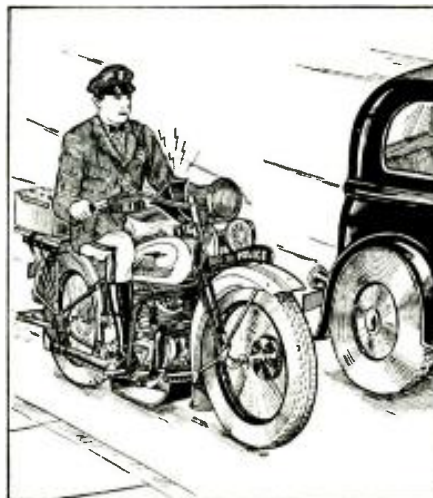

RADIO MINIONS OF THE LAW
"My! what big teeth you have, Grandma!"

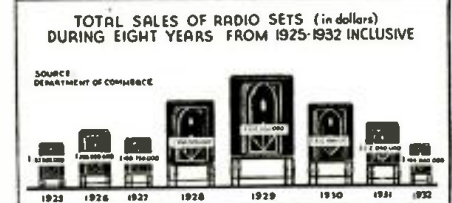
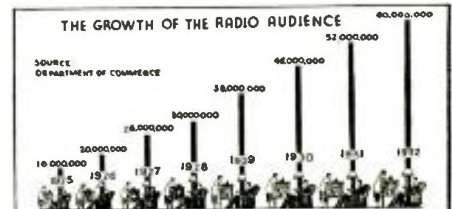

ASCAP vs. NAB
Is mechanization of music a flop?

THE MURDER OF MUSIC?

THE American Society of Composers, Authors and Publishers (ASCAP, to you) which is still dissatisfied with arrangements made with the Broadcaster has circulated a booklet with the title "The Murder of Music," in which they attempt to show by a series of graphs (three of which are reproduced here) that radio broadcasting assisted by the movies is responsible for the falling off of monies to composers and music publishers (approx. 80 per cent, according to their figures).

The contents of the booklet are reprinted in part below:

"From twelve to eighteen hours a day, every day, several hundred broadcasting stations repetitiously and endlessly din into the ears of millions of listeners old music and new music, good music and poor music—music sung, played, whistled, hummed and crooned, by artists and aspiring artists, by professionals and amateurs.

"These charts constitute a serious challenge to all who are interested in the continued creation of American music. Under present conditions the lovely art of music and its creators are being starved to death.

"A sad result of the mechanization of music is the effect upon employment of
(Continued on page 417)

RECENT RADIO DEVELOPMENTS

— ILLUSTRATED

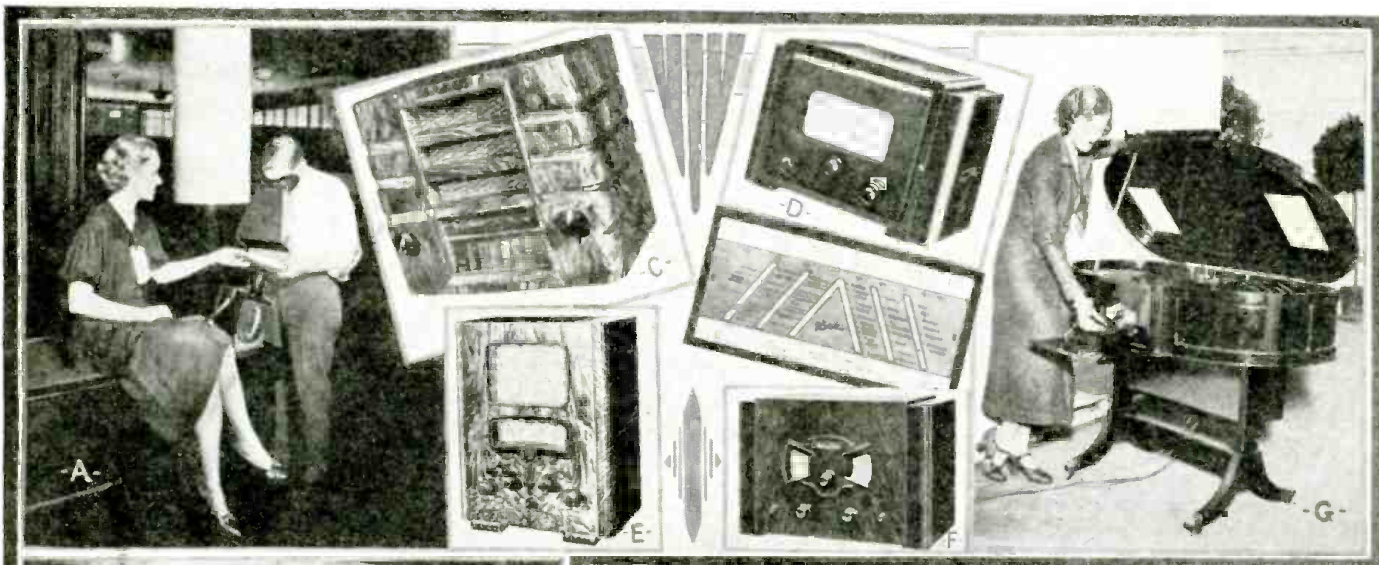

Figures A and B are two views of the smallest X-ray tube made in this country. It is rated at 58,000 V. and 10 ma. which is a marked contrast to the mammoth 800,000 V. tube recently installed in Chicago. It operates from an ordinary electric light outlet, and has many uses impossible with more permanent units.

In Figures C to G are shown some recent European developments in cabinet designs for radio sets. Figure D has a peculiar type of dial that shows directly which station is tuned-in. Figure G is a piano-shaped, combined radio and phonograph. It has space for many spare records.

Figure H shows a new television transmitter developed by Manfred von Ardenne, the well-known German inventor. This unit uses a Braun tube or oscilloscope which scans by a "spray" of electrons. These move fast across a dark area and slow where the reproduced intensity is to be most brilliant.

Figures I and J show a picture and layout drawing of a new German television receiver developed by Dr. Tug. George Schubert. This unit employs an endless, intermediate "movie" film which is exposed by the light from a television receiver; developed, and projected by a regular movie projector; and then re-sensitized. The process is repeated as long as reception continues. This system permits television images to be projected on a large screen.

A new acoustical wavemeter for measuring the frequency of sound waves has been developed at Indiana University. This unit gives a visual indication, being independent of the ear. Professor R. R. Ramsey and Dr. Herbert Hazel are shown in Fig. K with the apparatus which is shown schematically in Fig. L.

A German automotive radio set for limousines is shown in Fig. M, below.

Photo courtesies—A,B.—G. E. Co.; C,D,E,F,M.—Dr. A. Neuberger; G—Keystone; H—Dr. F. Noack I,J.—Dr. T. G. Schubert; K,L.—Indiana University.

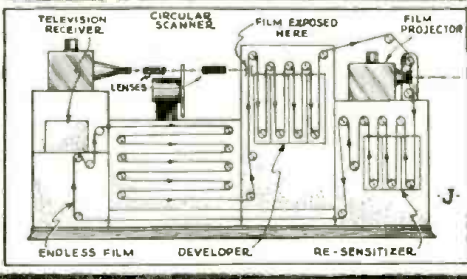
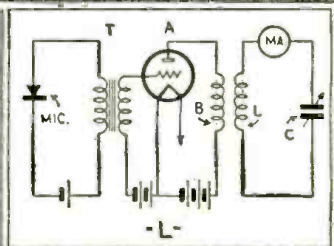
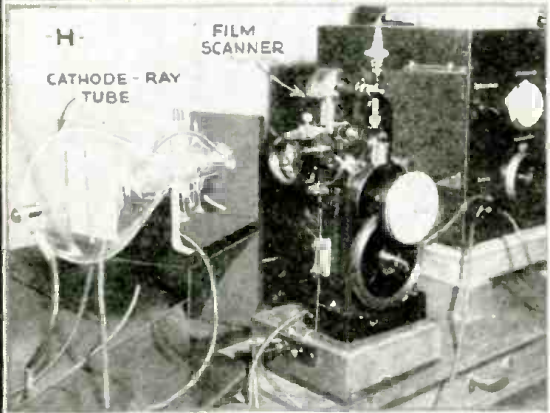

"DIALING" 42 WORLD-WIDE PROGRAMS

AT THE NEW RADIO CITY HOME OF NBC

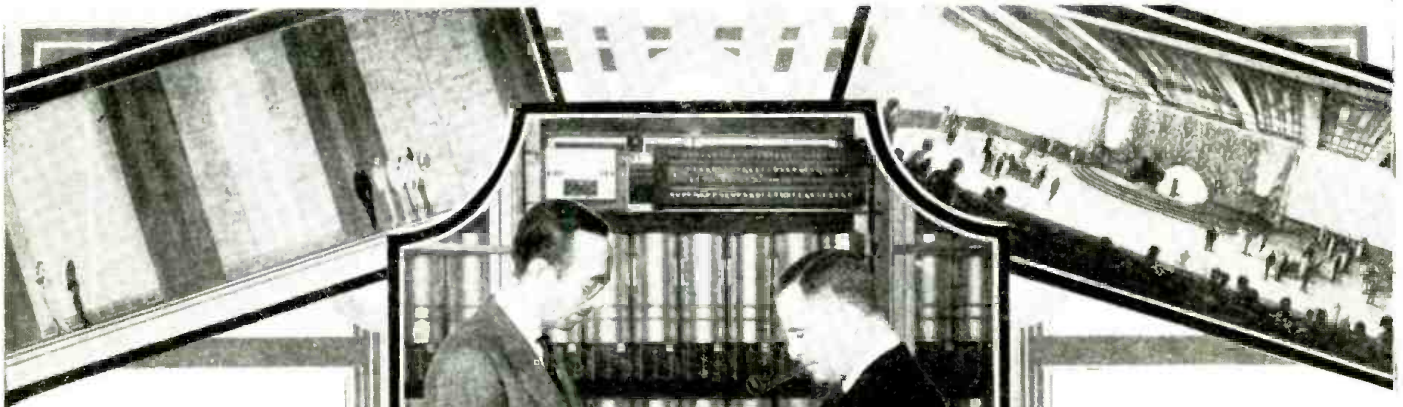

Sliding "acoustic" panels.

Most novel feature is being installed in the new offices of the NBC at Radio City, New York. This consists of a dial phone system in conjunction with a group of highly-sensitive radio receivers, so that the executives of this vast corporation can listen at any time to the programs being sent from any of the NBC studios, or any local or distant station "on the air."

"Each time a combination is dialed," explained O. B. Hanson, manager of technical operations, "it connects the office loudspeaker with a receiver (in a special monitoring room), which has been pre-set to the desired station or studio." Small buttons on the dial permit the listener to increase or decrease volume.

Mr. Hanson explained that certain combinations are used regularly for the networks and studios. For instance, to hear what is going on in studio 8H, it is necessary simply to dial that combination.

In addition, a daily list is distributed showing any special pick-ups which are to be made, such as foreign stations. Also, if an official of the company

desires to hear any special station not included in the 42 listings, he needs only to advise the monitoring control room and an engineer will "pull the station in" for him.

Richard C. Paterson, Jr., executive vice-president of NBC is shown to the right of the upper central photo trying out one of the dial units. He and Mr. Hanson are standing before the cabinet of dial selector switches.

The central illustration is part of a sketch of Radio City with the walls removed to show some of the 35 studios, including the auditorium studio shown in the upper right-hand photo. The latter is 78 x 132 ft. and is three stories high. A unique feature of this studio is the use of sliding sound-proofing panels. By pressing buttons in the control booth, the operator can slide back any or all of the panels to any degree desired, thus exposing resonant surfaces which reflect sound and make the studio more "alive."

The entire system is built to accommodate television.

Photos courtesy of NBC.

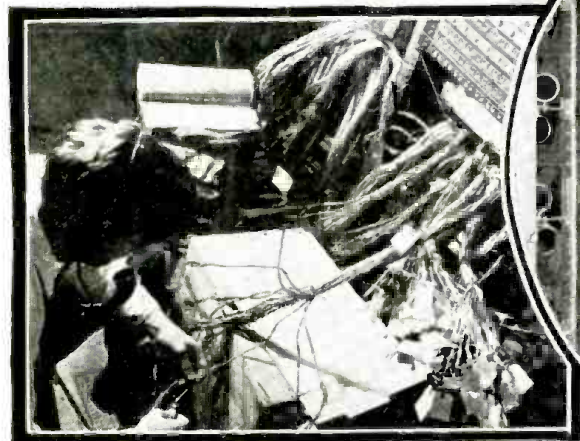
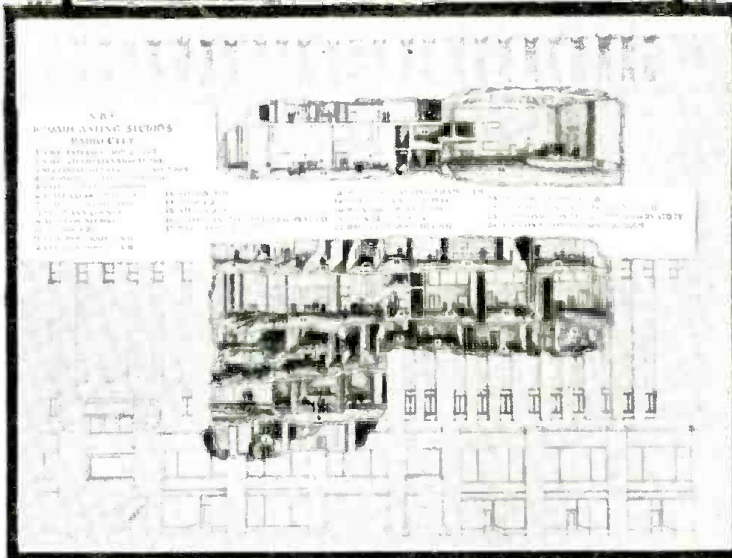

An engineer "tracing" dial-selector cable wires.

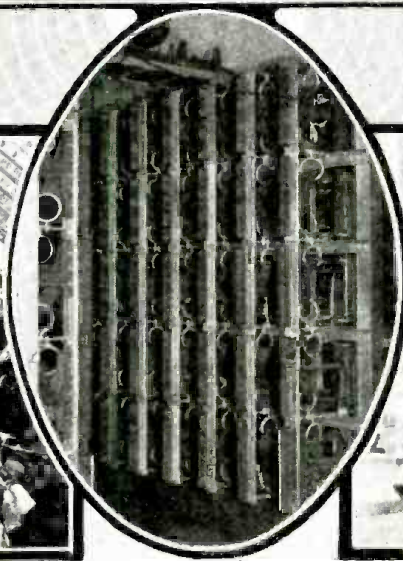

Cable terminal rack.

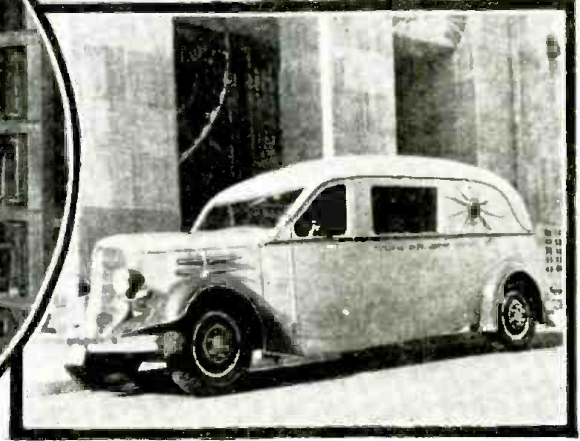

A mobile transmitter for sound and television.

LATEST RADIO EQUIPMENT



14-tube all-wave super. (No. 366)

ALL-WAVE SUPERHET.

AN all-wave superheterodyne receiver, using 14 tubes to supply the highest useful gain, with good tone quality, has been recently introduced. This set is entirely up-to-date in design, including inter-station noise suppression, amplified A.V.C., parallel push-pull power amplification, full-vision tuning dial for all wave bands, and automatic tone compensation.

This receiver covers not only the broadcast band, and the short waves from 9 meters up, but also includes the waves up to 2,000 meters. In this way, the powerful long-wave European stations, operating on wavelengths above the usual broadcast band can be tuned in. Technical details and a complete schematic circuit, with constants, appear on page 414.

MODERNISTIC SUPERHETERODYNE RECEIVER

THE modernistic set shown below is modern not only in appearance, but also in technical design. It contains 4 tubes, in a superhet. circuit; reflexed A.V.C.; a voltage-doubling plate supply and a 5 in. dynamic speaker. The tubes are as follows: 6A7, 43, 6B7 and 25Z5. The cabinet is 10¼ x 7 x 4¼ ins. deep.



Modernistic Set (No. 367)

Name of manufacturer of any device will be sent on receipt of a self-addressed, stamped envelope. Kindly give (number) in description under picture.

PHONOGRAPH CUTTING DEVICE

THE item shown here is a recording feed-screw device which moves any record cutting head across the face of the recording disc and thereby grooves the record at the time of recording.

There are no critical adjustments required in the operation of the device and the instrument will fit any phonograph turntable. Records up to 12 ins. can be accommodated and the thread is cut at the rate of 80 grooves per inch.

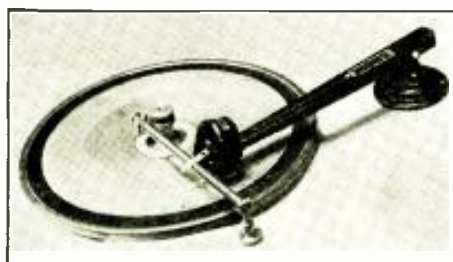

Recording mechanism (No. 368)



Unit analyzer (No. 369)

A UNIT-TYPE ANALYZER

THIS up-to-the-minute servicing kit is made up of 5 separate panels, each of which is complete in itself. The use of units of this type prevents the entire analyzer from becoming obsolete in case a new development in sets, tubes, etc., is introduced.

The first unit is a set analyzer with a rotary switch to permit any measurement.

The second is a tube checker for testing tubes up to 7 prongs—either size.

The third is a test oscillator which covers frequencies from 100 to 3,000 kc.

The fourth is a volt-ohmmeter using a 50 microampere basic instrument.

The fifth is a capacity meter with a microfarad and an A.C. voltmeter scale.

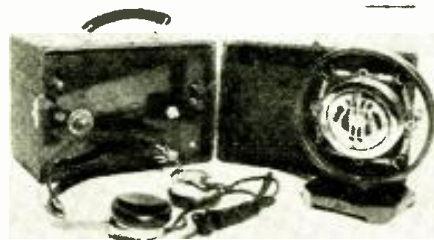

Amplifier system (No. 370)

DETECTOPHONE-STETHOSCOPE

THIS comprises a microphone system with a pre-amplifier, a power amplifier, a headphone, a sensitive microphone and several accessories such as a 25 ft. cord, gain control, etc. It weighs 5 lbs.

A DUAL-RESISTANCE INDICATOR

A NUMBER of unique features have been incorporated in this useful little device. The two wire-wound resistors covering two ranges from 0-100,000 ohms are wound with the heaviest possible size of wire, to insure long life.



Dual resistance inductor (No. 371)

P.A. SYSTEM AND 70 W. POWER STAGE

THESE two units have been designed to cover the needs of P.A. users, where more than ordinary coverage is required. The first unit is a complete P.A. system of high quality. The second is a power amplifier for super P.A. work.

(Continued on page 420)

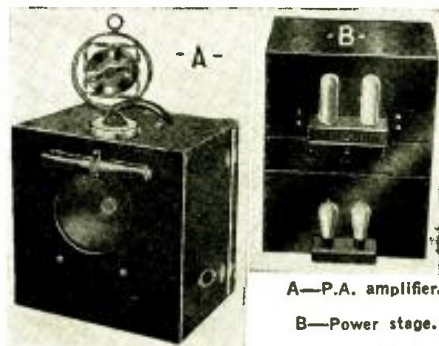

A—P.A. amplifier.

B—Power stage.

(No. 372)

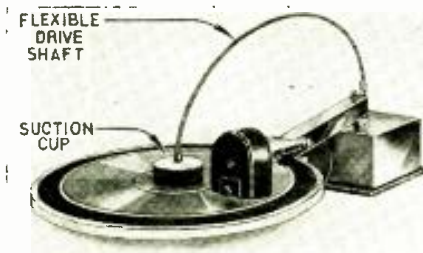

Record cutting device (No. 373)

RECORD CUTTING DRIVE

THIS unit permits high-quality recordings either from original sounds or for copying existing records. The equipment is simplified by the use of a flexible drive shaft on the record which carries the cutting head across the record, thus preventing vibration from affecting the "head."

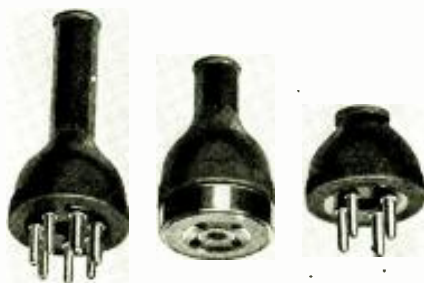

Cable plugs (No. 374)

RUBBER-CAPPED PLUGS

THIS series of plugs of both the male and female types has been designed for unusually hard usage such as encountered in portable P.A. work, etc.

They are available with either 4, 5, 6 or 7 prongs and receptacles for use with large or small cables.

MINIATURE PHONES

A NEW type of phone for use either with hearing aids or radio receivers has been introduced on the market. It is made to fit into the ear as shown below. Different types are available with resistance values up to 2,000 ohms. They have good frequency characteristics.



Miniature phone (No. 375)

THEATRE AMPLIFIER

SINCE the situation regarding talking movie equipment has changed, many companies are introducing new equipment to cover this fertile field.

The amplifier shown below is made entirely in duplicate so that if any piece of apparatus becomes defective, the "show can go on." Different types are available for either 4 A., 8½ V. or 5 to 7½ A., 10 V. exciter lamps, while the necessary potential of 50-120 is applied to the photocells.

Four stages of amplification are used, feeding into a 15 ohm speaker line, thus eliminating the necessity of using external matching transformers. The units include a self-exciter dynamic monitor speaker with a separate volume control. Tone control devices are provided to compensate for theatre acoustics. The meters indicate constantly the photocell voltage and exciter lamp current for quick check-up in case of failure.



Theater amplifier (No. 376)



Signal generator (No. 377)

SIGNAL GENERATOR

DUE to the complexity of modern circuit design, overall gain has increasingly become the criterion as a means for checking receivers. Not only has a mere rough check of sensitivity and selectivity become necessary, but very recently it has become more and more imperative to know their exact value.

In order to afford the Service Man with an instrument which will give him this information at a price which is within reason, a well known company has designed this signal generator.

This generator will supply an unmodulated broadcast signal of any intensity and frequency, with an accurate indication of intensity from ¼ of 1 microvolt to .1-volt. It will modulate a broadcast signal with a measured percentage of modulation from 0-50 per cent modulation. The dimensions of the unit are 10 x 5 x 8 ins. The weight is 15 lbs.

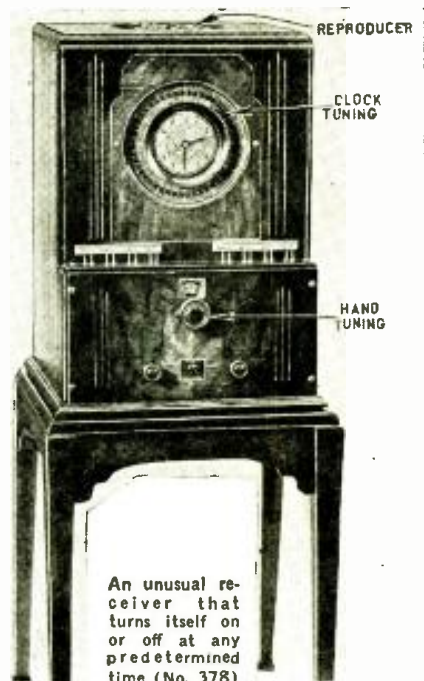

An unusual receiver that turns itself on or off at any predetermined time (No. 378)

AUTOMATIC RECEIVER

A RECEIVER that turns itself on and off and tunes itself to any one of 14 predetermined stations for any desired time has just been introduced.

This receiver is a distinct departure from usual set design and offers one more money-making item for the Service Man to "sell."

FIRE-SCREEN SPEAKER

THE resident in a home "boasting" of a fireplace will find this new speaker both ornamental and useful. It combines the "atmosphere" of the colonial home with the latest in radio reception.

A dynamic speaker with its own, heavy-duty A.C.-D.C. field supply is housed in this screen. The circuit diagram of this unit, Model 38, is shown in

(Continued on page 421)

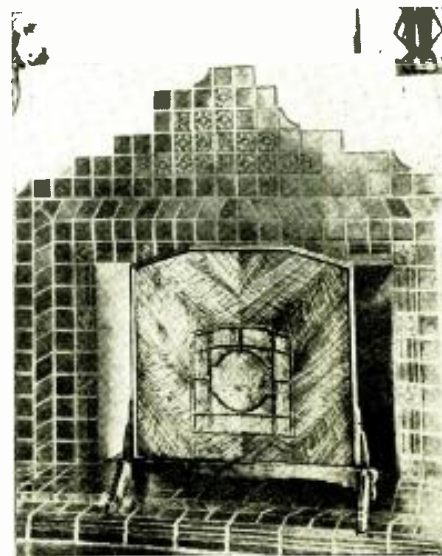

Fire-screen speaker (No. 379)



P. A. call system (No. 380)

INTER-OFFICE CALL SYSTEM

AN inter-office communication system for use in factories, manufacturing plants, offices, etc., has just been introduced. It consists of a 3-stage vacuum tube amplifier, a carbon microphone and one to five dynamic speakers, depending upon the requirements of the installation. The amplifier has a gain of 87 db. at 1000 cycles and a maximum undistorted output of 20 W. The amplifier operates from the 110 V., 60 cycle power supply line. It is housed in a case 18 x 10 x 9½ ins. deep, and weighs 34 lbs.

The output coupling device of the amplifier is variable so that it can be adapted to any number of speakers up to the limit of five.

LINE-MATCHING UNIT

IT IS frequently necessary to obtain various voltages from the 110 V. power lines. Transformers having taps for the various voltages are ordinarily used for this purpose, but have the disadvantage that a change in voltage necessitates an interruption of current, as one tap must be disconnected before another can be applied.

A practical solution of the problem of obtaining exact operating voltages.

The unit shown below overcomes this difficulty. It is a toroidal *auto-transformer* with a sliding contact on the winding. This supplies an unbroken variation from 0-130 V. by moving a knob on a calibrated dial; capacity 5A.

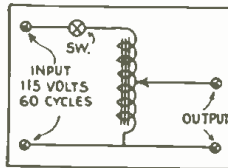

Variable auto-transformer. The circuit is shown at the left. (No. 381)

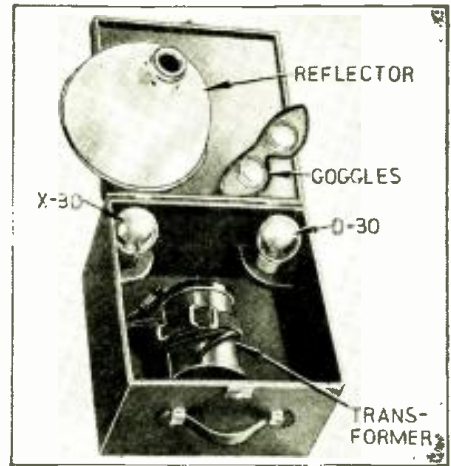

Ultra-violet light kit (No. 382)

ULTRA-VIOLET LAMP KIT

ALTHOUGH the radio Service Man may regard ultra-violet lamps as being out of his line, it is a specialty which is steadily gaining in popularity throughout all classes of homes. The kind of selling required, coupled with the simplicity of installation and instruction to the buyer, seems to indicate that ultra-violet lamps can become a profitable line to the radio Service Man.

Few Service Men would not welcome a legitimate way to increase business; the sale of these lamps is promising.

The reasons for this indication of success are somewhat as follows: There is much misinformation on the subject of ultra-violet rays. This means that correct information must be spread around. It is not expected that the Service Man

(Continued on page 420)

12-TUBE ALL-WAVE SET

A NEW superheterodyne receiver covering wavelengths from 15 to 550 meters is shown in the photo on the right. This receiver incorporates all the latest features; such as double shielding on the I.F. amplifier, A.V.C., tuning-light indicator, and a full-vision dial for all bands; with the ability to tune over both the short waves and the regular broadcast band.

The circuit diagram of the receiver appears on this page. It will be seen that a 4-section multi-point switch regulates the tuning from one band to another. The tubes used in this set are as follows: R.F., type 58; oscillator, type 56; first-detector, type 58; I.F., 58's; second-detector, Wunderlich; first A.F., two type 56 tubes in parallel; and, second A.F., two of the new type 2B6 tubes in push-pull.

The I.F. amplifier in the set contains three stages, comprising 8 tuned circuits, which, combined with the oscillator, antenna and R.F. circuits, makes a total of 11 tuned circuits! The I.F. transformers are litz wound and are tuned by air-insulated condensers to insure constant calibration.

The dial of the set is novel in construction. It consists of a needle-like station indicator which revolves over a full 280 degrees. The dial has a vernier ratio of 40 to 1 which eases the difficult task of tuning-in foreign stations on the short-waves.

Two audio amplifier arrangements are available for this receiver either single channel, or split and using two reproducers to cover the audio band.



12-tube all-wave super. Slow-tuning is a feature; as is "double shielding." (No. 383)

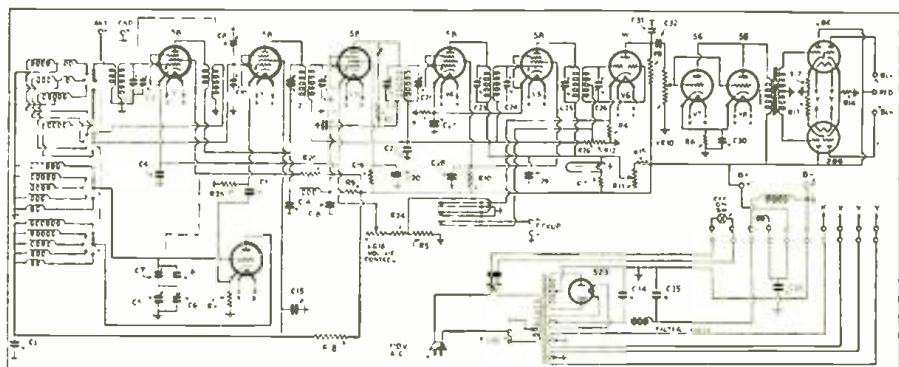

Circuit diagram of the 12-tube superhet.—all available data are shown.

INTERNATIONAL RADIO REVIEW

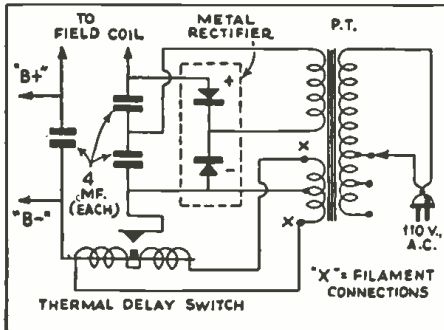

Fig. 1

The circuit of the metal-rectifier power unit.

A TUBELESS POWER SUPPLY UNIT

An interesting power supply unit was described with a modern super-heterodyne receiver that appeared in a recent issue of *POPULAR WIRELESS*, London, England. This receiver, which was introduced at the Olympia Radio Show, was given the name "The Olympia Super" to commemorate this fact.

The power unit is unusual in several respects. First, it uses a full-wave metallic rectifier, the output of which is fed into a voltage doubling circuit, as shown in Fig. 1. A thermal time delay switch is incorporated in the unit, so that the tubes in the receiver are heated with filament current first, before the "B" circuit is closed. This serves the double duty of protecting the rectifier from overload, and also tends to lengthen the life of the tubes in the receiver.

CABINET RESONANCE ELIMINATOR

AMATEUR WIRELESS, London, England, has contained several articles, in recent issues, on the subject of eliminating bass-note boom or cabinet resonance from speakers installed in the usual box-type baffle.

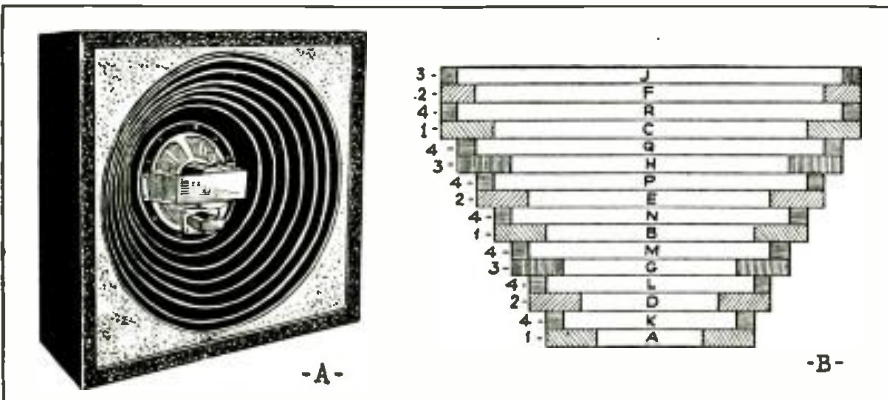

Fig. 2

Cabinet resonance can be avoided by the use of rings of sound-absorbing material.

HERE is what the radio experimenter has been wanting for a long time—a semi-technical review of the thousands of new ideas which are continually appearing in overseas publications. Each month there are received at the offices of *RADIO-CRAFT* hundreds of daily, weekly and monthly magazines originating from every point on the face of the globe.

SINCE the cost of subscribing to each of these would be prohibitive for most radio men, we have arranged with technical translators to prepare for our readers reviews of all the really important, new developments illustrated and described each month in these international radio periodicals.

NOTE that the only available information is that which is published; the experimenter must adapt the ideas to whatever equipment he has on hand.

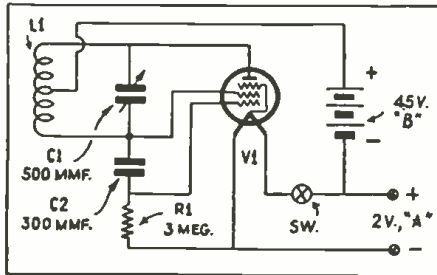

Fig. 4

A pentode oscillator for servicing work.

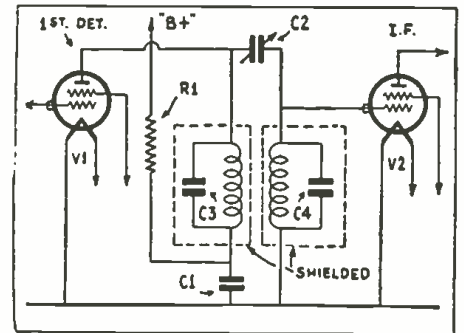

Fig. 3

Capacitive coupling adapted to I.F. circuits.

One method described, consisted of lining the inside of the cabinet with a fibrous material, known as slag wool. A canvas lining in the form of a funnel contained this material.

The second method, shown in Fig. 2, consists of inserting a series of air chambers in the cabinet, to absorb both the sound and mechanical vibrations. This is done by means of a series of rings and squares of a sound absorbing material, such as acousti-celotex. The smallest ring is placed at the front of the cabinet to which, of course, the speaker chassis is screwed. The size of this ring depends on the size of the speaker. The object is to arrange rings and squares of ever-widening radius from the center ring to the outermost square at the edge of the cabinet.

To make up this new form of baffle, only four complete squares of celotex are needed, each the size of the cabinet. Take one board and cut a circle, having a diameter of 15 ins. This leaves the square with a circular hole in the center which becomes piece "C" in the cross-section, Fig. 2B. From the remaining circular piece cut another circle 12 ins. in diameter; and from this last circle cut another hole, leaving a small ring

(Continued on page 429)

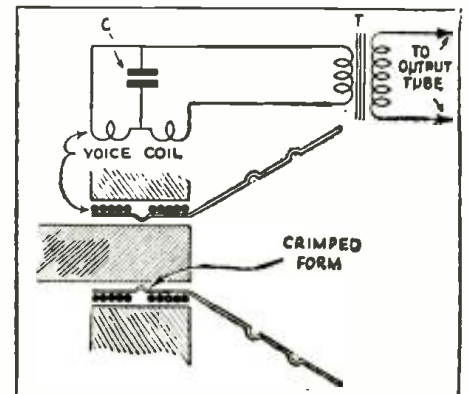

Fig. 5

Improved quality is claimed for this speaker.

HOW TO MAKE A RADIO GROWLER

FOR TESTING RADIO AND ELECTRICAL UNITS AND CIRCUITS

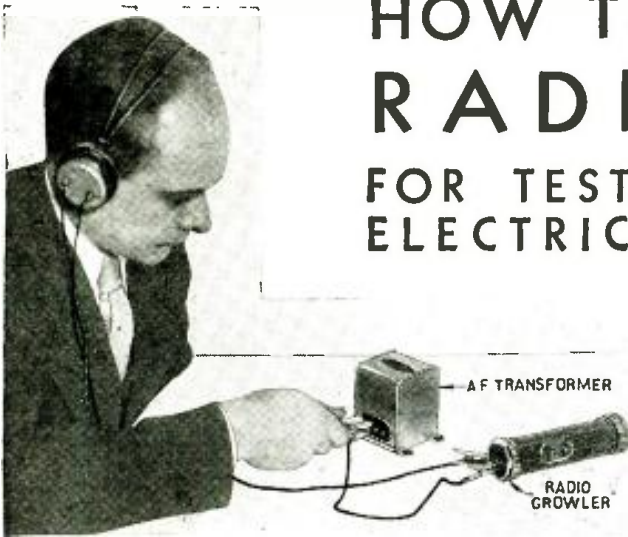

Fig. A

Use of the "growler" in testing the windings of an A.F. transformer.

SOME OF ITS USES:

Continuity tests in low-, medium-, and high-resistance circuits. For two-way code telegraphy; and as an R.F. circuit driver. Locating concealed wires, pipes and other conducting mediums. Tests for grounds, shorts and continuity of cabled leads. Finding shorts, grounds and opens in various units.

FRANCIS M. BECK

THE scope of the tests which can be made with the few simple bits of equipment herein described is surprising. Indeed, most of the material, if not all, can be retrieved from the shop "junk box" and the twenty-eight tests described are only a *part* of the tricks that can be done. Figure A shows test No. 7 being "used" on a transformer. Figure B shows the complete test equipment; it is entirely portable—except possibly for the magnetic collector. (Some day I shall make a more imposing looking, really portable collector, by mounting the iron plates on a hinged, stained and varnished oak board.)

For my own work, I have found a buzzer, fitted to replace the lens and reflector of a flashlight, very convenient. Note Fig. C and the two contacts (marked "battery" in Fig. 1), one of which is bent to form a short "L" that will just touch the central contact of one cell, and the other, the long L-shaped spring at the side of the case. The bakelite disc is keyed with a slot, to the case, so it will not turn.

Figure 1 shows the connections for the buzzer arrangement. It is frequently necessary to solder or connect a wire from terminal 2 to the inside of the buzzer. Terminal 1 must go to the free end of the magnet coil, and terminal 2 must be connected to the other end of the coil—the end of which also is connected to one of the vibrator contacts, as shown. Terminal 3 is connected to one of the battery terminals. (Unless the buzzer is of the "radio" type, giving a high-frequency note, it must have its contacts and springs bent, and paper wedges inserted between its armature parts, etc., until it will give a good high-frequency tone.)

Either a pair of phones or a single phone may be used. I use a single phone for listening; it is lighter to carry than two units. The parts of a second, single phone are required in making the search coil. Thus, a pair of phones is required.

After the search coil is assembled as shown in Fig. 2 it should be taped up, using narrow strips where necessary. (A coat of varnish will "kill" the sticky feeling of the tape.) If a magnetic collector (the search plates) is not going to be used, even the poles may be covered up.

The search-plate collector may be made as shown in Fig. 3, or in any other way that is convenient. The only requisites are that the plates be made of iron; that they make contact with the pole pieces of the search coil; and the parts which hold the plates and search coil together be made of a metal other than iron, or nickel. If desired, instead of clips, another search coil may be permanently installed.

Circuit Continuity Test

Use this test, Fig. 4-1, on low- and medium-resistance

circuits; closed circuit produces a buzz, open or high-resistance circuit results in no buzz.

Alternative.—Use this method, shown in Fig. 4-2, on medium- or high-resistance circuits. Hold the contact several seconds, (to charge circuit); an open circuit supplies little circuits—no buzz. Fig. 4-3.)

Ground Test

Use this test for low- and medium-resistance grounds; a grounded circuit gives a buzz, high-resistance or ungrounded circuits,—no buzz. Fig. 4-3.)

Alternative.—A more sensitive test than method No. 3. Hold the contact several seconds, (to charge circuit); circuit not grounded results in little or no click on contact. (Fig. 4-4.)

Transformer Test

For transformers with low-resistance primaries use the method shown in Fig. 4-5. A change in buzzer tone is heard if the secondary is shorted. (Alternative No. 6 is generally preferable.)



Fig. C

The flashlight houses both the buzzer and the battery.

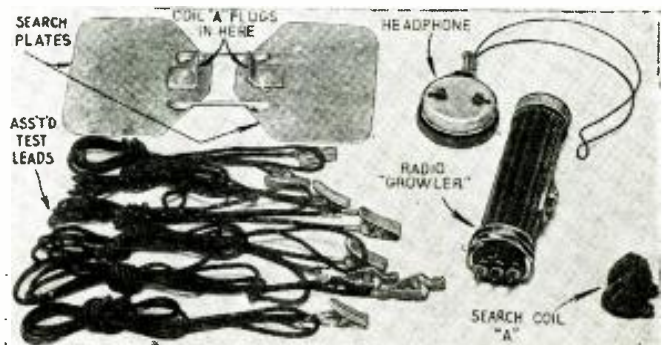

Fig. B

The entire layout of parts for the buzzer test unit.

Most test units are exceedingly complicated. Consequently, it is quite refreshing to find a really simple design in an instrument which, in the hands of even a tyro, is capable of many versatile uses. A head-phone and a buzzer constitute the essential components of this test device—a "growler" adapted from old electrical practice and redesigned to meet the needs of not only the electrician but also the radio experimenter and technician. Make this unit part of your regular test equipment.

Alternative.—For transformers having low-resistance primaries and high-resistance secondaries, use the test shown in Fig. 4—6. Good transformers cause a buzz in the phone; loudness varies with transformers and transformer ratios.

Alternative.—Use the method shown in Fig. 4—7, when primary resistance is so high that buzzer will not operate through it; good transformer causes a buzz in phone.

Condenser Test

The method shown in Fig. 4—8 indicates very defective condensers; shorted condensers show a buzz. (Alternative No. 9 is much more sensitive and generally preferable.)

Alternative.—Hold contact some seconds, longer for large condensers. After allowing time to charge, a good condenser causes little or no click. A shorted or leaky condenser causes a continued loud click. (Fig. 4—9.)

Alternative.—Charge as explained above; let stand some time, then test remaining charge. Small condensers cause a weak click; large condensers, a loud click. Leaky or shorted condensers after standing produce little or no click. (Fig. 4—10.)

Line Tests

This method, shown in Fig. 4—11, shows how to pick a wire from a number of wires in a cable. When both clips are on the same wire you hear a buzz.

Alternative.—Use the method shown in Fig. 4—12 when the resistance of the line and ground return is so high that the buzzer will not operate. When both clips are on the same wire a loud buzz is heard in the phone.

Picking a Pair from a Group of Wires

Where no ground return is available, use one of the wires to complete the circuit as shown in Fig. 4—13.

Alternative.—Use this method (Fig. 4—14) on long, or high-resistance lines, or where a phone indication is more desirable.

(Continued on page 430)

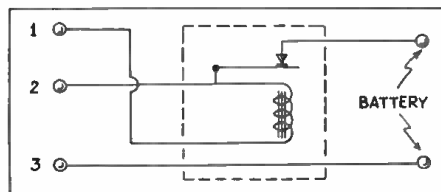

Fig. 1, above; Fig. 2, right
The schematic circuit of the buzzer. And, details of the search-coil unit.

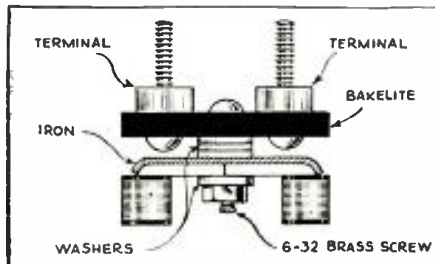

Fig. 3
Details of the search-coil plates.

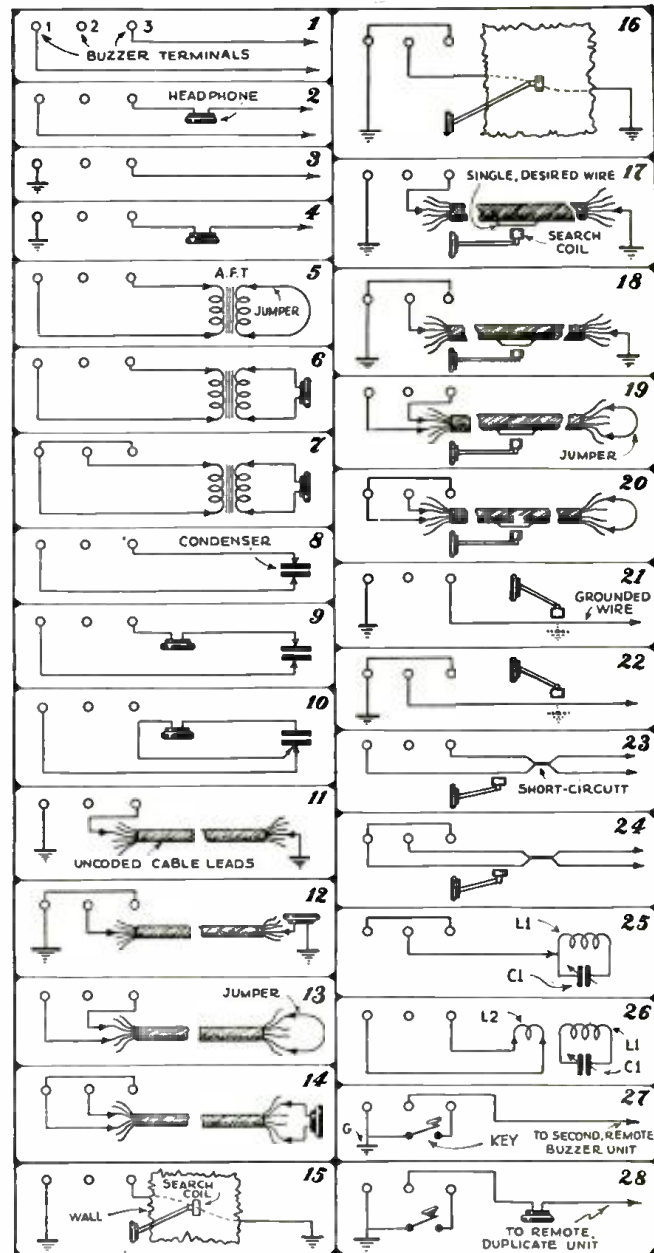

Fig. 4
Some of the many possible tests which may be made.

LIST OF PARTS

- One pair 2,000 ohm headphones (without headband);
- One single-phone headband;
- One Signal, type R-60 high-frequency buzzer (assembled as described; see Fig. 1);
- One set of search-coil plates (the magnetic collector shown in Fig. 3);
- One Eveready No. 2604 flashlight case (with battery);
- One search-coil (made as shown in Fig. 2);
- Six miscellaneous leads (make up as required).



Fig. G
Two amplifiers are mounted on three racks.

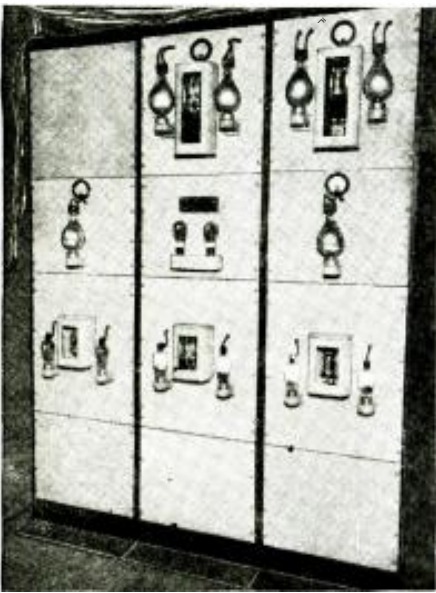

Fig. H
The D.C. filament and plate supply panels.

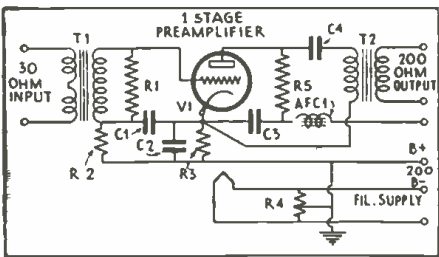
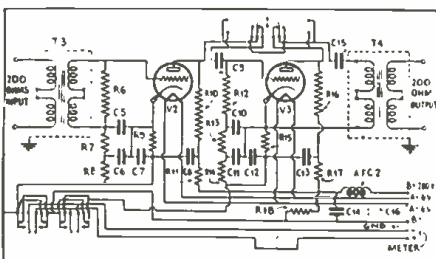

Fig. 2
The single-stage pre-amplifier circuit.



A SUPER-POWER AND-QUALITY P.A. SYSTEM

In Part I of this article were described the mechanical details of the \$100,000 super-sound system at "The Romance of a People" pageant—here are the electrical features.

C. W. PALMER **PART II**

WHILE it is not feasible for the average experimenter to construct P.A. systems of this type, due to the difficulty in balancing the individual amplifier circuits, etc., we are showing the wiring diagrams of the units so that a better understanding of the effects can be given.

It might be well to state here that direct current is used for the tube filaments. This is necessary because the frequency response of the amplifier is "flat" to a frequency well below the power supply frequency of 60 cycles. If alternating current were used for the filaments, there would be a strong pick-up of the 60 cycle hum which would be projected by the bass-note speakers, and no practical filters would eliminate this difficulty.

8-Cycle Transformers

The transformers used in the entire system were hand wound in the laboratory of the manufacturer and have frequency response characteristics that run
(Continued on page 437)

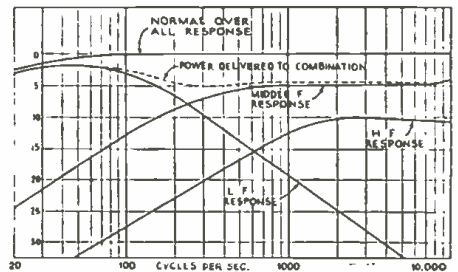

Fig. 6
From 30 to almost 20,000 cycles, flat!

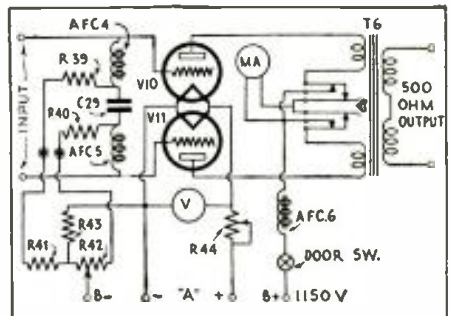

Fig. 5
One of the push-pull power amplifiers.

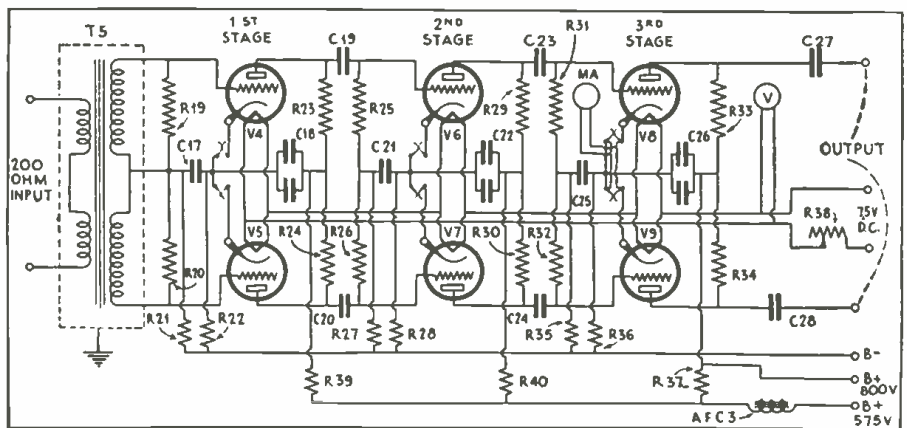
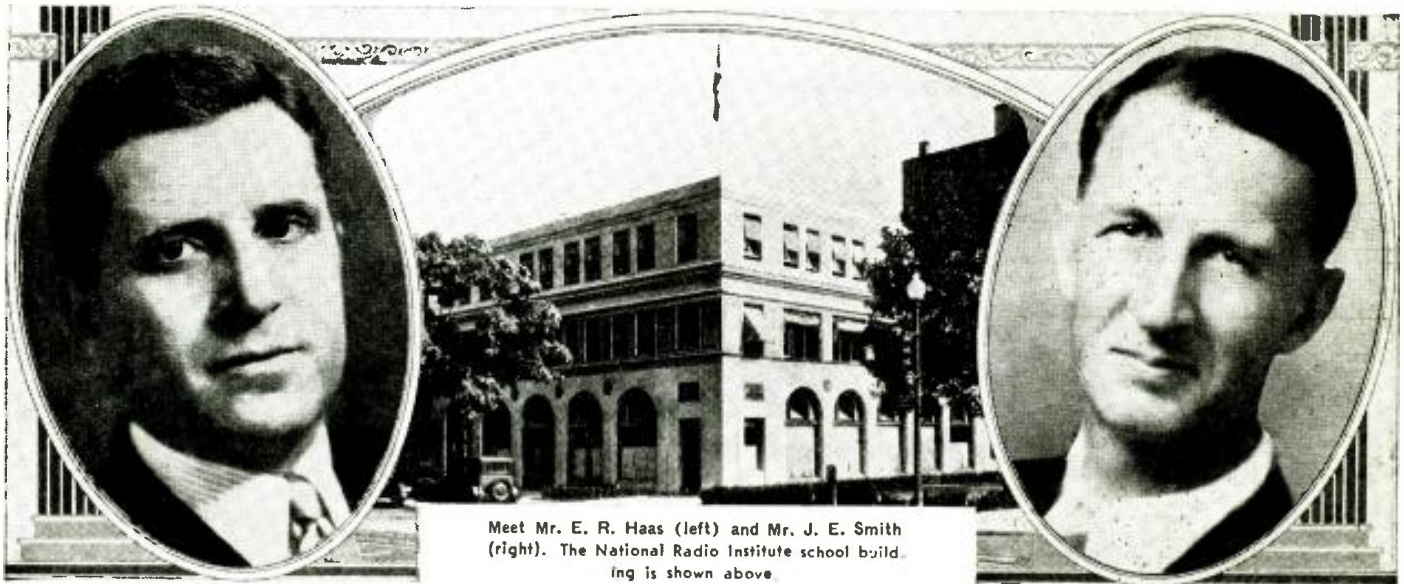

Fig. 4, above
The 3-stage voltage amplifier circuit. Double resistance coupling retains the high quality.

Fig. 3, lower left
The 2-stage pre-amplifier feeding into the voltage amplifier shown in Fig. 4, above.



Meet Mr. E. R. Haas (left) and Mr. J. E. Smith (right). The National Radio Institute school building is shown above.

THE 20TH BIRTHDAY OF A RADIO SCHOOL

This month marks the 20th anniversary of a famous radio school. In this article, Mr. J. Kaufman tells how the school developed with the radio industry to its present world-wide prominence. A genealogical table illustrates the point.

J. KAUFMAN*

NO ONE can review the history of radio from the days of "wireless" (colloquial reference to code communication by radio—*Technical Editor*) without feeling that scientific miracles have been worked and that twentieth century civilization has been greatly enriched. A radio school which started in the "wireless" days and which has kept up with radio's kaleidoscopic development down to the present, can look back upon its own history and probably feel that its own growth and the achievements of its graduates parallel the romance of the radio industry.

A radio school to be worthy of recognition must contribute to the radio industry, which means that the men it trains must be fitted for useful places in it. Such a school renders a valuable social service to its graduates, as well as to the industry.

Basic Knowledge is Essential

The first aid to sound training in radio, as in every other field, is an intimate understanding of what has been done. Sound experience built up over a long period of years is the best

anchor among the many currents and tides which are continually sweeping through radio and altering its surface appearance. Only a knowledge of the past will enable a school (or a man) to avoid the pitfalls of the present. This is not enough, however. A keen understanding of what is actually going on in the industry is of immediate importance in training men to meet their present problems and it insures, also, accurate gauging of the future, so that men are trained to cope with the problems of the future as they inevitably crop up.

Contrary to popular belief, the creation of a radio course is the result of constant and long continued effort on the part of an educator and staff of instructors thoroughly versed in the various branches of the science, and experienced in gathering, arranging, and presenting facts. To teach effectively, it is necessary to comb the entire radio field and analyze every development for probable future tendencies, months and often years ahead.

It is just as essential that the personal qualifications and requirements of the men to be trained be kept thoroughly in mind. Their background, ambitions,

THE TREND OF RADIO DEVELOPMENT

Government	Maneuvers	Army
	Messages Navigation aids	Navy Gov't business Time signals Weather data Facsimile Newspaper Coded
Commercial	Pictures	Telephone Typewriter Multiplexing Message traffic Dispatching Warning
	Trans-Oceanic & Continental	Distress Communication Navigation
	Railway	All-wave, Short- & Broadcast bands Moving pictures Sound projection Photo-cell pickup Recording & Reproducing
Broadcasting	Mobile Ship, Aircraft & Land	Home receiving Remote control Automotive radio Analyses & tests Measurement
	Voice programs Television Home talkies	Repairing Noise location A.C. & D.C. Power circuits Hotels & hospitals Apt. houses Halls, outings Theatre & Studio Machine control Light, elev. & Draught control Alarm systems Color matching Counting, grading & sorting Analyses
Home use	Radio	Traffic control Analyses Measurements Piano, Violin, Organ & Theremin Curative & surgery Speeding growth Killing insects Prospecting & Geophysics Ultra-high frequencies Light-beam transmission Altimeter, Recorder Sonic & Super-sonic work Remote control
	Maintenance	Serviceing
Measurement		
Sound Projection	Public Address Talkies Power	
	Industrial	
Electronics	Musical Inst's Medicine Botany Biology	
	Radio & Electronics	
Research		

*Director of Education, National Radio Institute.

(Continued on page 422)

RADIO SHORT-CUTS

Hints, "kinks," ideas and suggestions that enable the amateur and professional to save time, money and equipment.

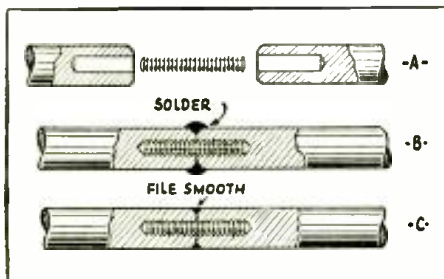

Fig. 1
Lengthening the shaft.

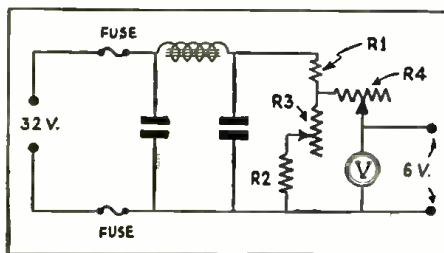

Fig. 2
A 32 V. farm "A" supply.

SHAFT EXTENSIONS D. Vernon Chambers

I HAPPENED across a job with a thick panel and a line switch so located that it took about a 1 $\frac{3}{4}$ in. shaft overall to make the proper replacement. And the following kink came back to me; it is used in the blacksmith game. Take an old shaft from a condenser or an old rheostat, brass is best, and bore a $\frac{1}{2}$ -in. deep hole with a $\frac{1}{8}$ -in. drill in the switch shaft and addition, as shown in Fig. 1. Get a screw about $\frac{3}{4}$ -in. long that will just slip in. Put one shaft in a vise and half fill it with solder; then dip the screw in soldering paste and shove it into the shaft. Do the same with the other shaft and press them together, keeping them hot. When the solder sets, hold them at right angles in the vise and fill the space between them with solder all the way around. When cool, file down even and you have a job that will hold. About 30 minutes work saved me a trip to town, and the expense involved.

32 V. FILAMENT SUPPLY Frank Myer

I OFFER a 32 V. filament supply circuit, for a battery set, which may be a help to radio men in rural communities, where the 110 V. line is not present. (See Fig. 2). Values for 01A tubes follow.

Resistor R1 is 12.5 ohms with a capacity of 60 W.; R2, 5 ohms; and R3 and

R4, (rheostats) about 6 ohms.

For 199 type tubes: R1, 45 ohms; R2, 7 ohms; R3 and R4, 20 ohm rheostats. Choke coil should be able to carry 3 amperes.

"CHECKING UP" THOSE R.F. CHOKES

A NUMBER of methods for testing R.F. chokes have been devised in the past. One of these methods was recently described in *WORLD-RADIO*, London, England.

Chokes may be tested for their good conduct by means of any controllable regenerative circuit covering the frequencies or wavelengths at which the choke is to be tested. In many cases a radio set itself can be used, but it is a simple matter to rig up such a circuit as that of Fig. 3. The tuned circuit L1, C1 should be as efficient—free from loss—as possible. It will then oscillate very easily, with the oscillation condenser, C2, at a low setting of the scale. The beginning of oscillation can be detected by listening in on a nearby receiver, or by watching a meter in the plate circuit.

On connecting the choke, R.F.C., across L1, C1, with no additional leads (any that are necessary should be already in position) two things will happen. The frequency of oscillation will be shifted by the self-capacity or inductance, whichever predominates. And the threshold regeneration setting will be changed due to the loss introduced by the choke. Both these effects should be small in a good choke. They can both be measured—the first by noting the shift in C1 required to restore the original frequency. If C1 has to be decreased, then the choke is effectively a capacity; if increased, it is a negative capacity, or in other words, an inductance. The equivalent resistance of the choke is estimated by comparing the effect on the setting of C2 with that of small resistors of various values.

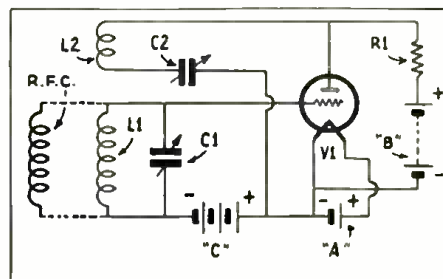

Fig. 3
Testing the "choking" ability of R.F. chokes.

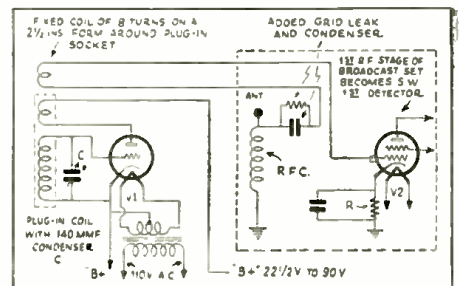

Fig. 4
A simple form of short-wave converter.

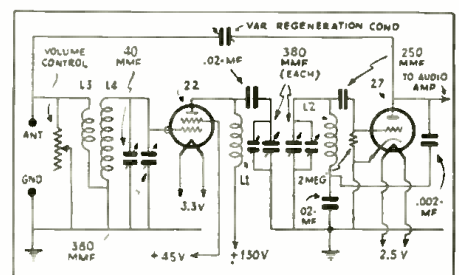

Fig. 5
Modernizing old Freshman receivers.

AN EXTERNAL OSCILLATOR FOR SHORT WAVES

Kenneth W. Kean

AS MY sketch, Fig. 4, shows, very little needs to be done to any set with an untuned screen-grid first stage, to convert it into an S.W. superheterodyne. It will, perhaps, be a little harder, if the first stage is a 27.

I have tried other methods of mixing but this is the simplest and most efficient. A switch to cut out the biasing resistor, R, might help the first-detector, V2. My set is a Silver-Marshall Model 30.

Once the broadcast set is tuned to a clear channel (around 1,500 kc. if possible), all the tuning is done on the oscillator. With the set tuned to 540 kc. and a suitable plug-in coil used, the outfit becomes a broadcast superheterodyne and works fine, too.

The antenna stays right on the broadcast set.

IMPROVING OLD FRESHMAN SETS Clarence A. Glover

THOSE having occasion to modernize the old Freshman QD-16-S usually find that the most common complaint is lack of selectivity. A few simple changes will cause a vast improvement in this respect.

(Continued on page 424)

READERS' DEPARTMENT

A department in which the reader may exchange his thoughts and ideas with other readers.

TETRADYNE—A LA HEISER

Editor, RADIO-CRAFT:

About a year ago, I made the Tetradyne, model H2, which was described in RADIO-CRAFT and was designed by Mr. H. Hill.

I fussed with this set for almost a year and tried all the suggestions Mr. Hill could give, but I just could not get anything on the short waves, below the police band.

I had many supers. previous to this one and always had good results and I could not understand why this one would not "perk."

Among other things, I replaced the combined oscillator and first-detector with a separate first-detector, but this did not help.

Finally, I replaced the 175 kc. I.F. transformers with 465 kc. coils and removed a few turns from the oscillator coils and then tried the set out on the 25 to 45 meter band. The first station I picked up was London, England.

The following are stations I have received to date on the short waves.

Call	Wavelength	Location
DJD	25.5	Zeesen, Ger.
DJA	31.38	Konigswusterhausen, Ger.
DJC	49.38	Zeesen, Ger.
GSD	25.53	Daventry, Eng.
GSA	49.58	Daventry, Eng.
GSB	31.50	Daventry, Eng.
GSE	25.28	Daventry, Eng.
FYA	25.00	Paris, France
12RO	25.40	Rome, Italy
EAQ	30.40	Madrid, Spain
HBL	31.20	Geneva, Switz.
VE9JR	25.53	Winnipeg, Can.
VE9GW	49.17	Bowmanville, Can.
VE9DR	49.96	Drummondville, Can.
WEA	28.27	Rocky Point, N. Y.
W3XAL	49.15	Bound Brook, N. J.
W2NE	25.40	Wayne, N. J.
W2XAF	31.40	Schenectady, N. Y.
W3XL	46.70	Bound Brook, N. J.
W3XAL	49.50	Cincinnati, O.
W8NK	25.26	Pittsburgh, Pa.
W9NF	31.50	Chicago, Ill.
WEF	31.30	Rocky Point, N. Y.
W8NK	48.80	Pittsburgh, Pa.
W2NE	49.02	Wayne, N. J.
W3XAU	49.50	Philadelphia, Pa.

I have also heard many other stations whose calls I could not understand. I will appreciate it if you will print this so that Mr. Hill can see what results I have had with his set after getting it to work.

EDWARD M. HEISER,
Route 2, Box 124,
Brooksville, Ohio.

CASH IN "FILTERIZERS"

The following experience of a moderate size radio dealer, whose shop is shown in Fig. A, is a splendid example



Fig. A
Mr. H. I. Phillips' radio shop and truck.

of how an enterprising dealer with initiative to grasp an opportunity of serving his community better, has cashed in during the past season selling and installing aerial filterizer systems for eliminating noise pick-up by the antenna lead-in.—*Technical Editor.*

We have sold and installed over fifty Tobe aerial filterizers this past Fall and Winter and every installation that we have made has been highly successful. The customer is more than pleased with the reduction in radio noise. One particular customer of ours who bought a Stromberg-Carlson receiver from us some time ago and who has been a chronic complainer of radio noise ever since said, after we had installed a filterizer on his premises at a cost to him of \$32.00, "For several months I



"And how is the set going, sir?"
"Like an express train."
"Er—indeed, sir?"
"Yes, it whistles at every station!"

(From Wireless Magazine)

had been able to hear only one strong station in Hartford. The local radio noise blanketed all other stations. After you installed the filterizer, I logged 26 stations on the receiver without any interference from the local radio noise." (The abnormal cost of \$32.00 resulted from the necessity of shielding electrical equipment on the customer's premises, indicating extended possibilities in radio noise service work.)

In general, the cost of the aerial filterizer plus its installation runs between \$12.00 and \$18.00. Filterizers can be installed at a smaller cost to the customer, but to give the customer the type of an installation that really makes a satisfied radio listener, takes time and a small bit of experimenting in each case. However, we have never had one case of radio noise that our Service Men have not been able to lick by the proper installation of the aerial filterizer system.

One of the outstanding means of finding so many prospects for the aerial system is that we pay our radio salesmen a commission on each filterizer kit installation they sell. The salesmen understand that they should try to sell a filterizer system with each receiver they sell, not only for the assurance that the receiver will stay sold in noisy areas, but to eliminate the necessity of expensive free service calls when the set owner is bothered with a new noise that may develop in a hitherto quiet neighborhood.

Figures obtained show that our salesmen were responsible for the sale of 40% of the kits installed and that our radio Service Men were responsible for the other 60%. The Service Man obtains splendid opportunities to talk confidentially and in an authoritative manner to customers whose receivers he services in the home.

HAROLD I. PHILLIPS,
Willimantic, Conn.

A BOOST FOR "TALKIES" SERVICE

Editor, RADIO-CRAFT:

I have just read Mr. Aaron Nadell's article on servicing the talkies and wish to thank the staff of RADIO-CRAFT for bringing this to the radio Service Man.

For a long, long time I have been wondering whether or not we would ever get a chance to service theater equipment and now it looks hopeful.

(Continued on page 438)

HOW TO MAKE THE BEGINNER'S PIANOTRON



Fig. A
The Pianotron in operation. This musical instrument is played like an organ.

Musical instruments of the "electronic" type are becoming more and more popular. This unit in the form of a 16-key electronic piano "plays" individual notes, is easy to build and will afford the builder a lot of entertainment.

FRANCIS R. HARRIS

finally the use to which we are going to put them this month—the production of a musical instrument.

RADIO principles and radio parts—though the fact is not well known to the average radio experimenter—are used in many ways other than for transmission and reception of broadcast programs. In fact, the latter use is coming to be one of the smaller fields of application. The identical apparatus and principles are used for such widely different purposes as measuring the thickness of paper to insure its uniform manufacture; counting the number of operations made by a machine; grading cigars according to color; opening and closing doors when someone approaches them or guarding those same doors against unauthorized approach; measuring the distance from ship to shore or from an airplane to the ground; guiding airplanes so that they can be safely flown and landed in a fog so dense that no light, however powerful, would be of the slightest use and

A Home-Made Musical Instrument

We have previously built a number of radio sets, each different in design, but all having the same purpose; to take music from the air and reproduce it for entertainment. These sets all use practically the same parts arranged in different hookups. We are now going to use those same parts, plus a small, mica-type variable condenser, arranged in another hookup but this time we will have not a reproducing instrument, but one which will allow us to create our own music.

However, it will be, to all intents, a radio set—just like the others, depending upon the same principles of vacuum tube circuits which underlie their action. Remember the super-heterodyne we built, and the explanation of how it worked? Remember how we demonstrated the heterodyne action by producing squeals between a regular broadcast frequency and

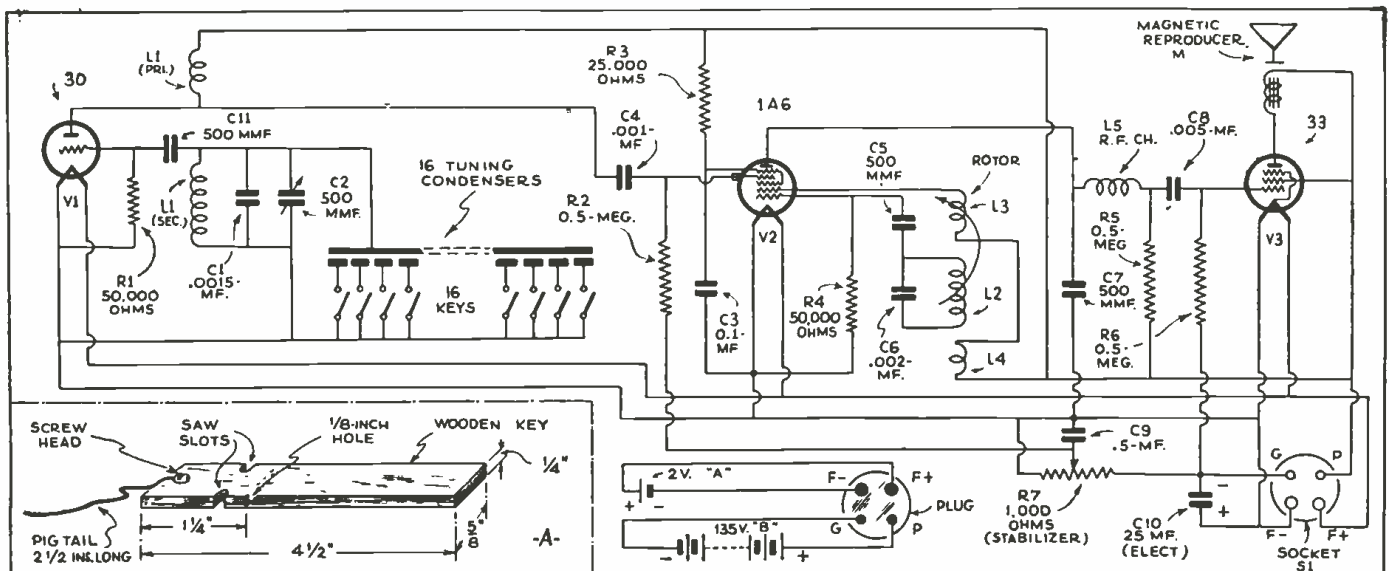

Fig. 1
The schematic circuit of the instrument. It will be seen that it is fundamentally made up of two R.F. oscillators and an audio amplifier.

WHAT WILL THIS "PIANOTRON" COST ME TO MAKE?

For the man who has been following the series of beginner's articles, the entire cost will be less than \$2.00 for a semi-variable condenser, and some wood and sheet metal for the panel and sub-panel. All other parts will be on hand if previous Beginner's articles have been followed.

For the man who has not constructed the previous Beginner's units, the cost will, of course, be higher. But even here, the amusement and education that will be derived will be well worth the small cost.

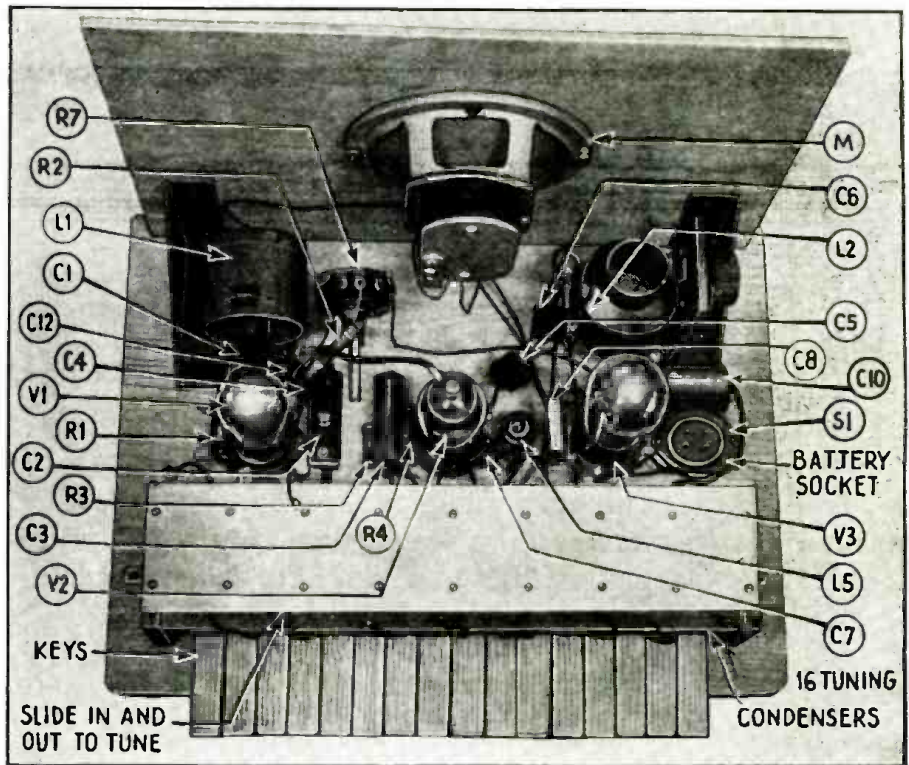

Fig. B

The rear view showing the locations of all the parts and the details of the key board.

that of our super's oscillator? (RADIO-CRAFT, September, 1933, page 160.—*Technical Editor.*) Of course in the design of a radio receiver the presence of such squeals is very undesirable and every effort is made to keep them out but in the present case the operation of our apparatus depends upon their presence.

There used to be an old joke about the Chicago meat packers who used every part of the pig but his squeal; we are going them one better, we are going to use every part of a radio set—including the squeal!

Principles

Suppose we set up two R.F. oscillators and couple them through a common circuit into an amplifier tube feeding a loudspeaker. If we tune these oscillators so that they are

oscillating at exactly the same frequency there will be no beat between them and hence no sound in the loudspeaker. If, however, we tune one of the oscillators to a frequency differing by 60 cycles per second from the other we will immediately hear a 60 cycle tone in the loudspeaker. This same thing will occur for any difference between the two frequencies so long as the *difference frequency* is audible.

Having a means of producing an audible tone of any pitch we desire, all we need to make a musical instrument is some way of conveniently producing these tones in steps corresponding to the musical scale in any definite sequence we desire—either as full notes, or in combination with half-notes.

(Continued on page 432)

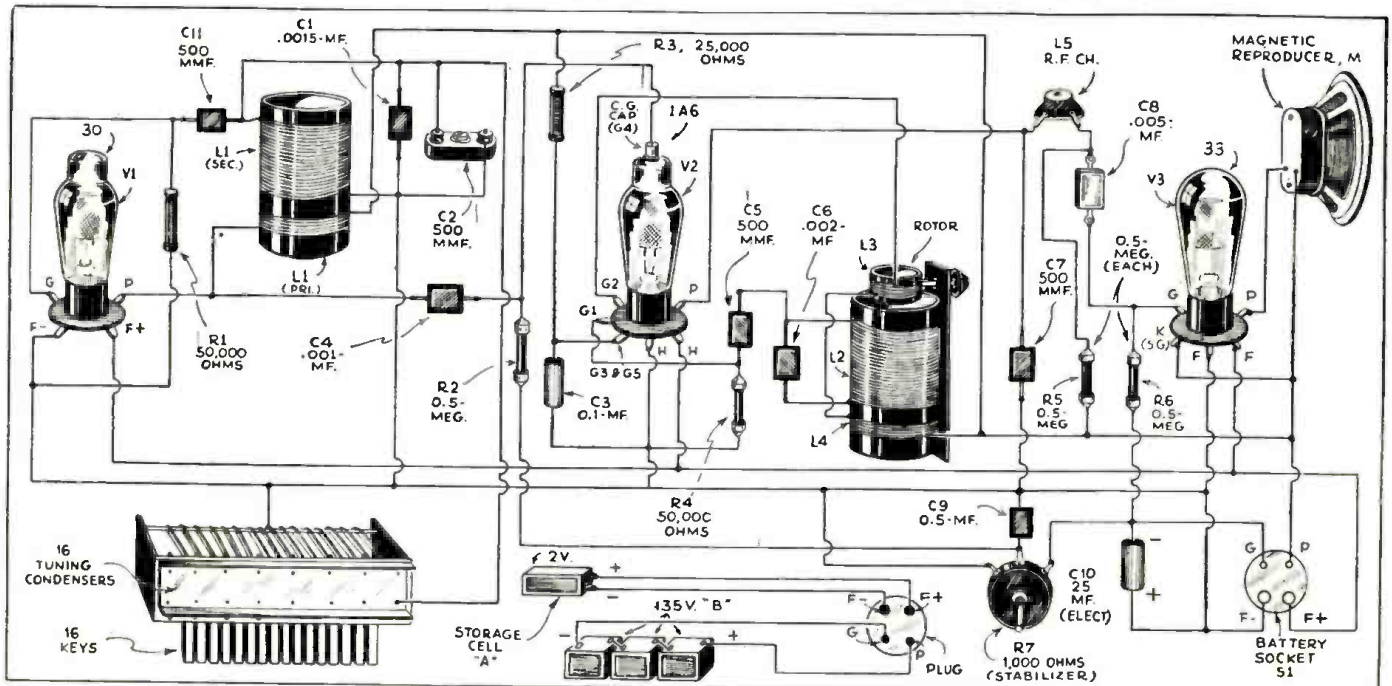

Fig. 2

The picture diagram of the Pianotron, which the beginner will find easier to follow than the schematic circuit.

HOW TO MAKE A MODERN CAR RADIO SET

An "honest to goodness" 7-tube superheterodyne receiver which includes all the latest features such as A.V.C., remote control, push-pull A.F. amplification, tone control and "B" power from a motor-generator. Although descriptions of auto-radio receivers have appeared in past issues of RADIO-CRAFT, none have contained the concise details of this one. Part I discussed the mechanical construction; the electrical details, plus coil data appear here in the concluding article, Part II.

PART II ████████████████████ HEINZ A. MUELLER

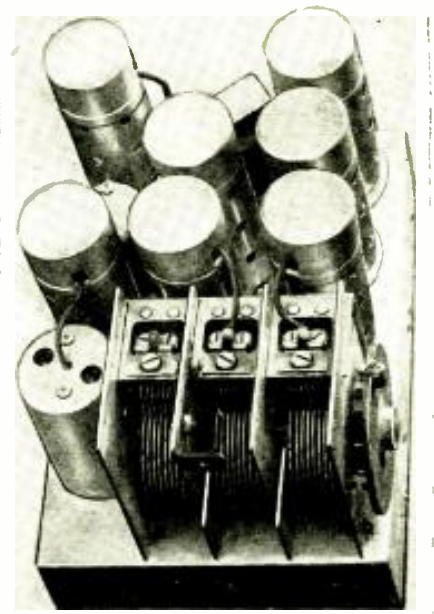

Fig. A
One model of the car radio.

TO CONTINUE the design of the auto radio receiver which we began in the last issue, Fig. 15 shows a general wiring diagram of the complete set and all the accessories. The radio set consists of 7 tubes used as follows: one type 39 tube as first R.F. amplifier, one type 39 tube as a combination first-detector and oscillator, one type 39 tube in the I.F. stage, one

type 85 tube as a combination second-detector and A.V.C., one type 37 tube in the first A.F. stage, and two type 89 tubes in push-pull as second (output) A.F. stage.

Wiring the Chassis

The whole wiring job of the chassis can easily be accomplished by following the connections shown on this general

wiring diagram and adhering strictly to all resistor and condenser values specified. Connect the wiring to the chassis socket as shown in Fig. 9 (shown last month) where the back view of the socket is given—the actual view of the socket when looking into the chassis. The cables as specified in the parts list are also shown in the general wiring diagram and all the accessories such as

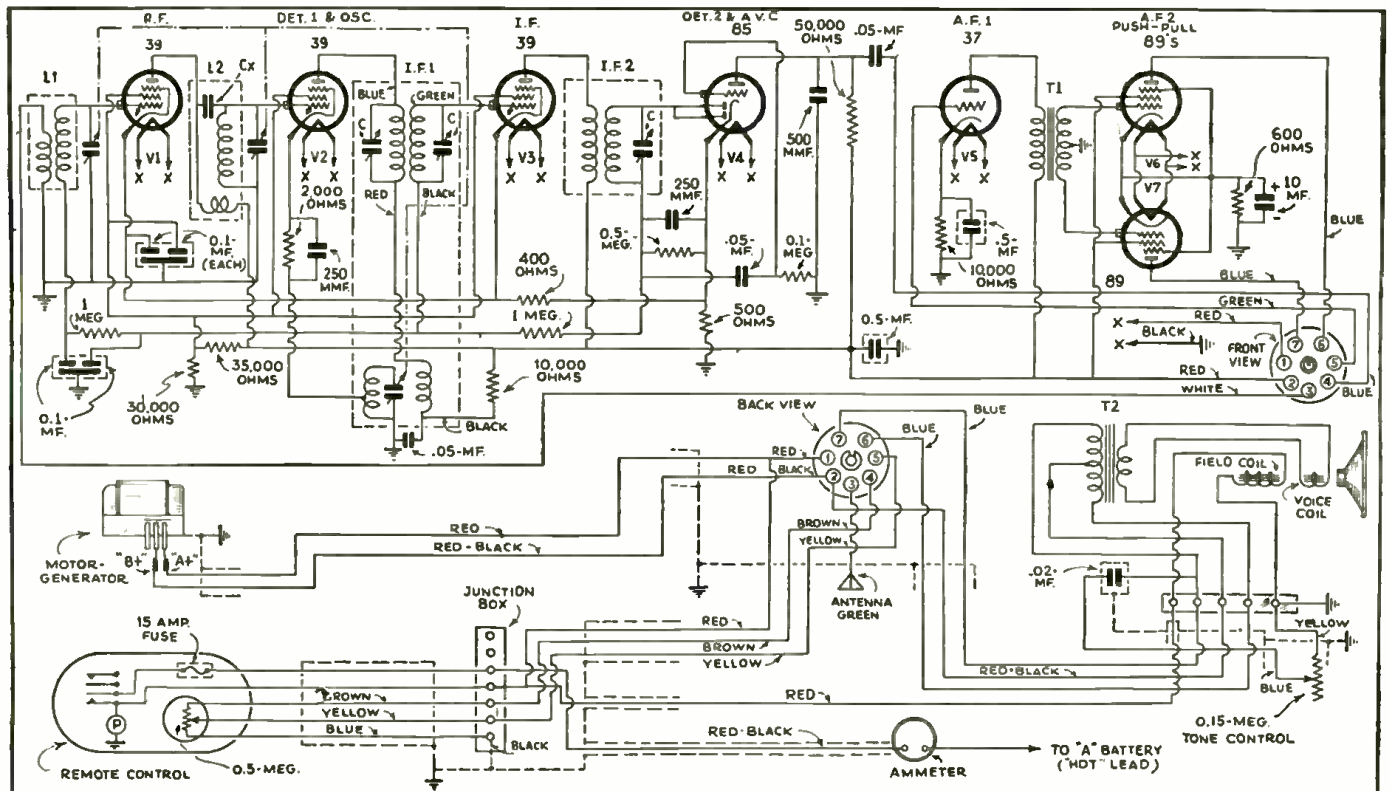

Fig. 15
Schematic circuit of the automotive superheterodyne, showing the cable wiring to the motor-generator, car battery and aerial.

the remote control unit, Fig. 16, the speaker unit, Fig. 17, and the plug and socket drawing, Fig. 9, are combined as one unit on the general wiring diagram.

From the remote control box, one cable is connected to the ammeter and one cable with three wires is brought from the remote control junction box to the plug. From the plug, one cable with two wires is shown going to the motor-generator and one cable with three wires is connected with the speaker. Another cable with one wire makes connection between the remote control and speaker. When making connections to the cables, tie all the cable shields together and securely ground the shields.

When making the coil connections, refer to Fig. 18 where all the coils are shown and their respective connections explained either by color code or numbering. A study of this drawing should answer any question better than words. Figure 19 shows the composite I.F. oscillator coil (P-20); Fig. 20 shows the antenna, R.F. and I.F. Coils, parts Nos. 18, 19, and 20, respectively.

Referring again to Fig. 17 it will be noticed that the tone control consists of one .15-meg. variable resistor in conjunction with a .02-mf. condenser. The variable resistor can either be mounted directly on the speaker box, or by means of the bracket shown in Fig. 21; the tone control can be mounted underneath the instrument board of the car, thus making the operation of the tone control easily accessible for the driver.

Figure 22 shows a proposed installation of the entire unit and accessories in the car. The chassis, together with the chassis box are mounted under the rear floor. However, in certain instances the chassis box can also be mounted under the rear seat. The mounting is done by cutting a hole in the floor board to provide an opening for the box. When making this hole be sure to make hole not larger than the actual perimeter of the box itself. After putting the box in place, mark the four corner holes and the box cover holes. Then drill the four corner holes through and countersink the other markings to make clearance for the 8-32 bushings on the box itself, thus assuring a flat seating of the box rim on the floor board. The chassis box is then fastened to the floor board at the four corner holes with round head bolts. (The same also applies to the motor-generator box if one is used.) The chassis is then placed in the box, and the packing and box cover are put over it. After the boxes are assembled in the car and all the adjustments on coils, as well as trimming condensers are made, close the boxes with the covers and the car carpet can now be put over the floor again, making the whole installation invisible to passengers. The remote control can be secured to the steering rod, the speaker can be placed on the dash board or wherever desired and the remote control junction box placed in one corner of the front com-

(Continued on page 426)

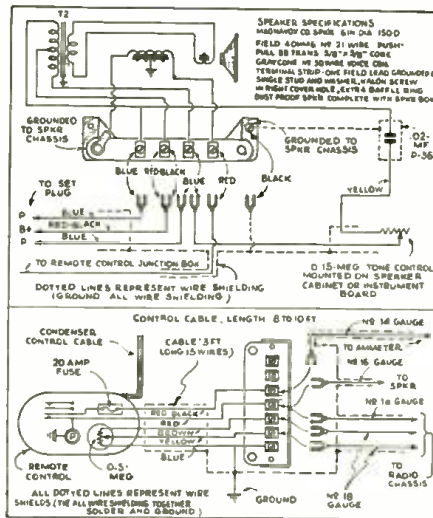

Fig. 16, top; Fig. 17, bottom.
Speaker and remote control wiring details.

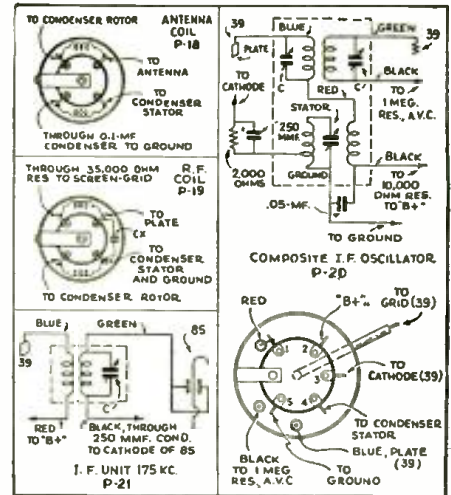

Fig. 18
Connections for the aerial, R.F. and I.F. Coils.

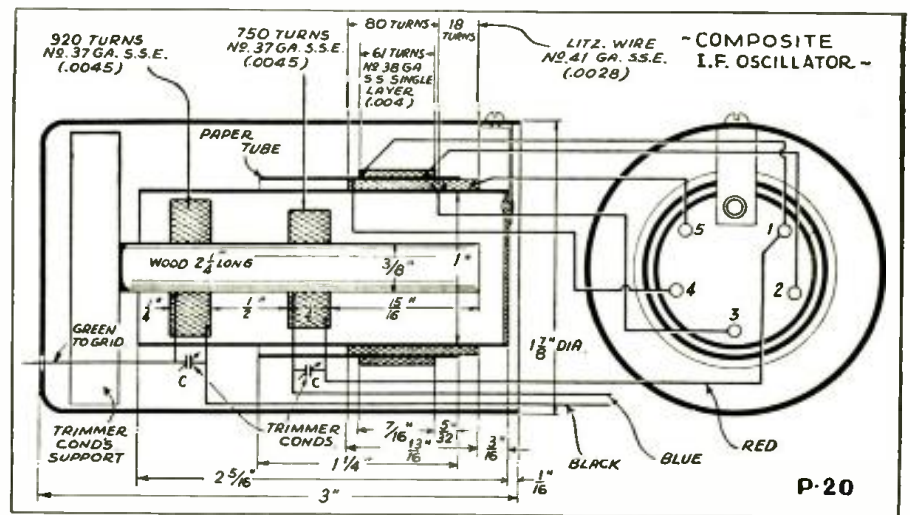

Fig. 19
Constructional details for the composite I.F. and oscillator tuning coil unit.

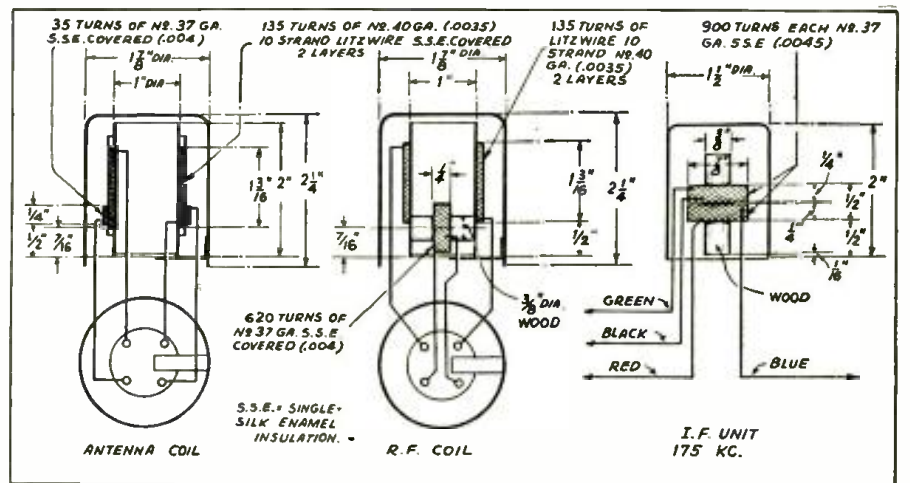

Fig. 20
Constructional details for making the antenna, R.F. and I.F. coupling coils.

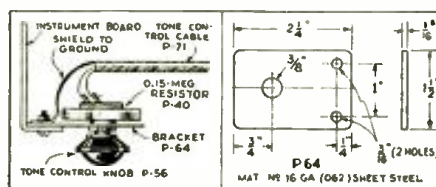
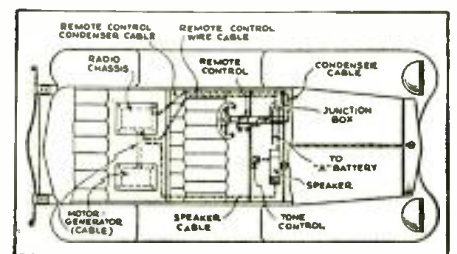

Fig. 21, above; Fig. 22, right
Tone control with bracket. Complete installation.



SERVICING THE "TALKIES"

In the November, 1933 issue of RADIO-CRAFT we announced this new series. In the present article the author continues his preceding detailed discussion of a representative sound talking motion picture installation—the "talkies" system of a Metropolitan theatre.

PART III AARON NADELL

THE preceding installment of this series pictured a theatre sound installation, rather larger than the typical system, but one that contains almost every type of sound apparatus likely to be found in a theatre. A portion of the equipment shown in those pictures was described at that time.

Before going on to describe the rest of this installation, however, it should be helpful to present a diagram of the elementary relations between the various portions of the system. Such a diagram, Fig. 3, accompanies this article—a block schematic, showing in outline how the different parts of the installation are hooked together. Only "speech" lines are shown; the power supplies are omitted to avoid confusion, but are mentioned in the description below. Also in the interests of simplicity, the four emergency amplifiers are left out of the block schematic; they switch into the "synch.-non-synch.-announcing" panel at one end, and to the matching auto-transformer at the other.

By referring Fig. 3 to the illustrations previously shown, the reader will readily note that the electrical sequence of the apparatus, as drawn here, has very little to do with the physical distribution of the various parts. Those parts are scattered about the projection room, and other rooms adjoining it, as convenience of operation dictates, and are wired

IN SUCCEEDING ISSUES—
 Mr. Nadell will continue his discussion of this timely subject. The topics will include—

- (1) A continuation of the description of theatre sound equipment from a semi-technical point of view.
- (2) An exposé of the problems, functions and psychology of the theater manager.
- (3) An outline of the background, psychology and problems of the average projectionist (without whose cooperation the radio man can get nowhere).
- (4) A detailed analysis of the conditions under which the Service Man can offer superior service and assistance to the theatre.
- (5) Suggestions of methods of sales approach to both manager and projectionists that will produce results.

to one another mostly through conduit and a central connection box. Because of their positions, and the network of conduit interconnections, these scattered parts often create an impression of complexity and confusion that in fact does not exist, the reader will agree that nothing could be simpler or more straight-forward than the actual relationship shown in the block schematic. That schematic should be compared carefully with the pictures printed last month, and with the written description that follows.

(Continued on page 434)

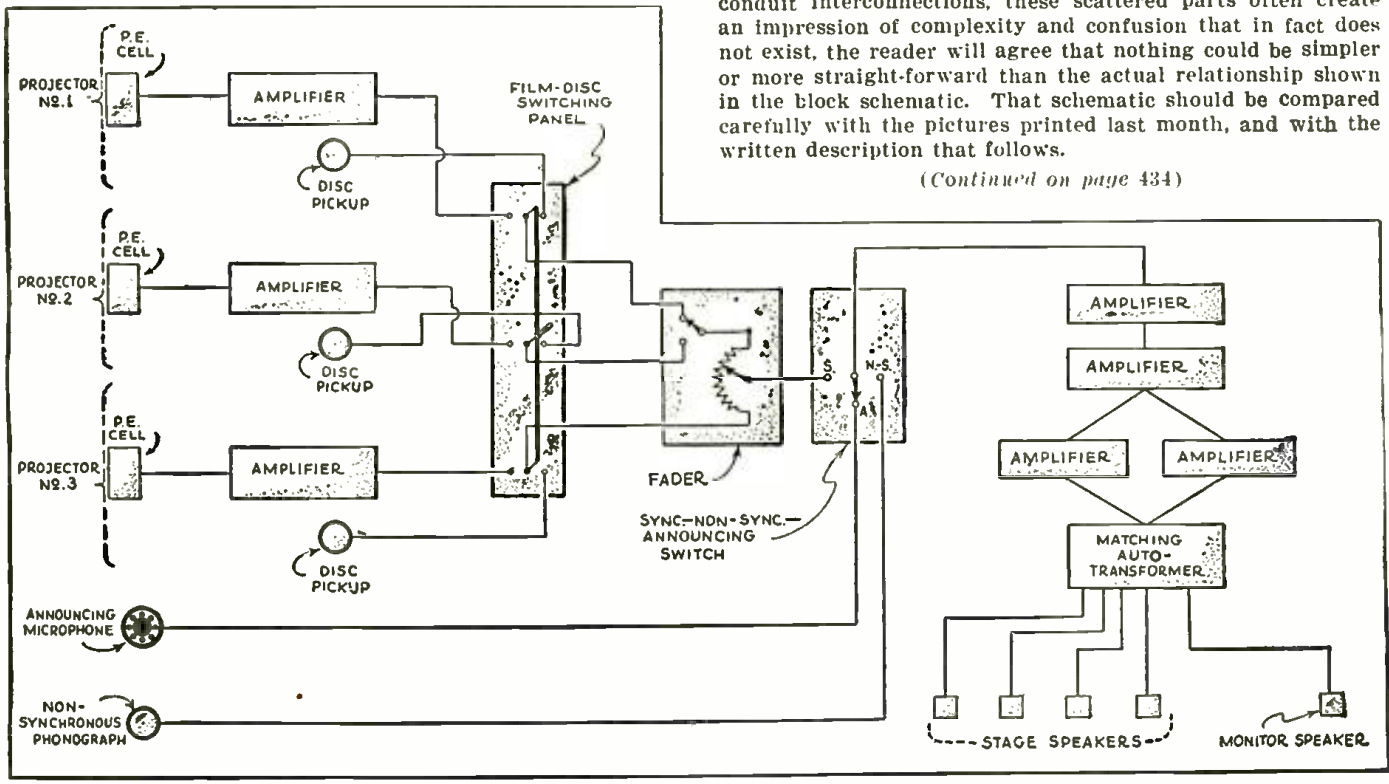

Fig. 3

The sequence of units in the sound system shown last month. Three projectors are used, feeding into a common power amplifier unit.

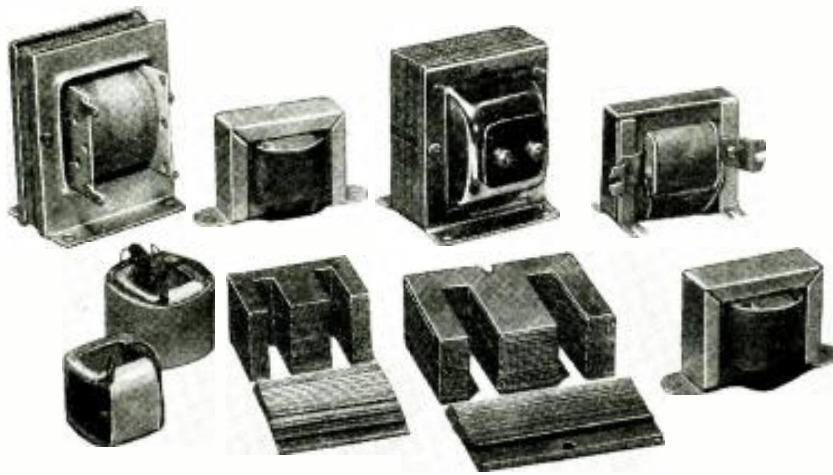

Fig. C
Various types of A.F. transformer components and the assembly of these units.

A. F. TRANSFORMERS
Although past issues of RADIO-CRAFT have contained considerable information concerning the design and construction of A.F. transformers, a good part of this information has been entirely theoretical. Consequently, this article by Mr. Lester H. Carr will be of exceptional interest, since it combines the theoretical and practical viewpoints.

HOW TO MAKE YOUR OWN TRANSFORMERS AND CHOKES

PART II

LESTER H. CARR*

THE design and construction of A.F. transformers vary greatly from that of power transformers. Audio transformers must pass a wide range of frequencies (evenly) while power transformers work on a single frequency. The losses in A.F. units are very serious because they vary with frequency thus causing poor frequency characteristics. The loss in core material is due to eddy currents and to hysteresis. The eddy currents vary as B^2 , F^2 , and t^2 , where B is core flux density, F is frequency, and t is the thickness of laminations. The hysteresis loss varies with $B^{1.6}$ and F. From this we can see that the loss increases rapidly at the higher frequencies, also that the flux density should be kept low and that thin laminations should be used. It is needless to say that the highest grade of transformer steel should be used if the transformers are to have an even response up to high audible frequencies. The flux density should be kept low not only for the purpose of keeping the eddy currents down, but also to prevent any saturation which would cause harmonics to be generated in the transformer output. This can be accomplished by having a large core. Because small air gaps at the butt joints tend to prevent saturation, these joints are preferable where a considerable amount of D.C. is flowing in the transformer winding.

*Consultant Engineer, Franklin Transformer Company.

Two Important Factors

There are two very important factors to be considered in building the windings of A.F. units. First, the primary and secondary windings should have very close proximity to prevent too much flux leakage; and second, the capacity across the windings due to capacity between turns should be kept at a small value.

This shunt capacity (the sum of the inter-turn capacities) not only tends to attenuate the high frequencies but also forms a series resonant circuit with the leakage reactance which results in a peak of high magnitude in the frequency characteristic at this resonant point. In high-grade audio transformers this resonant point is raised to as high as 20,000 cycles by keeping the above mentioned factors low, while in poor units this is sometimes as low as 4,000 cycles. Regardless of the fact that the amplitude of this resonant peak can be lowered by using more resistance in the secondary winding, it is important to keep this resonant point at a high frequency, because, above the resonant frequency, the winding acts like a condenser and the response drops off rapidly. It is very desirable to use "pi" windings when possible, along with double silk or cotton covered wire in coil construction, to limit the coil capacity.

It might be well to mention here the different methods of shielding used in transformer construction. A static shield consisting of a strip of thin cop-

per between the primary and secondary prevents any *electrostatic* coupling between the two coils. This is an important feature in A.F. transformers such as those used in the input and output circuits of P.A. amplifiers or other equipment located where surrounding interference often causes the equipment to be unstable and noisy. Such construction is also of great importance in radio transmitters to prevent R.F. voltages from feeding back into the speech equipment where it would cause undesirable effects.

In addition to the *static* shield is a *magnetic* shield consisting of a high-permeability metal box which encases the whole transformer. With this feature the unit can operate in a high magnetic field without any injurious results.

Core Material

Turning now to the consideration of high-grade commercial A.F. transformers in use at the present time, we find that the cores of such units are not of the ordinary silicon steel type but are an alloy of steel and nickel. This kind of core has a very low loss and a high permeability making it possible to decrease the number of turns greatly and still have the correct inductance.

By thus decreasing the number of turns in a winding the effective capacity of the winding is decreased, thus raising the high-frequency response. Further, all units except those to be

(Continued on page 428)

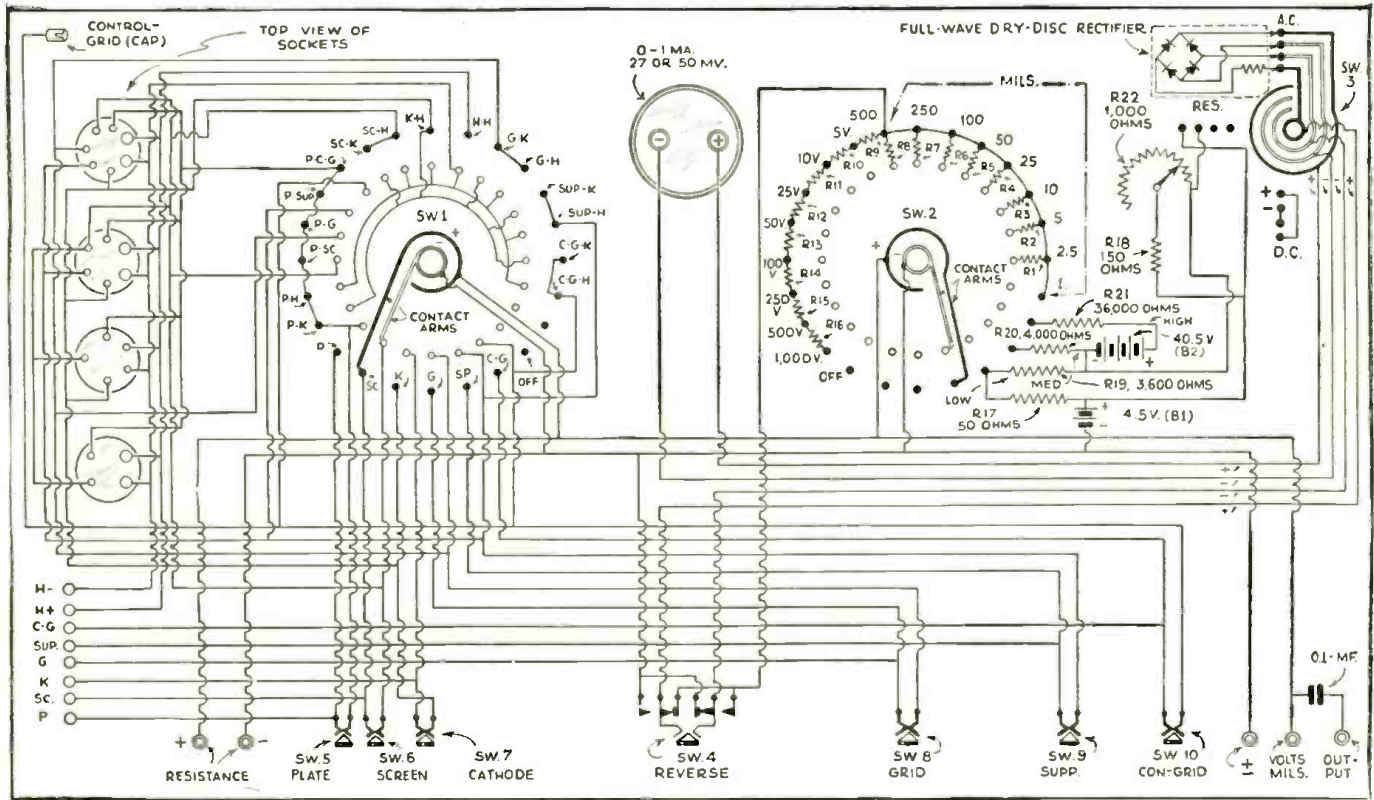

Fig. 1

Schematic circuit of the Ultra-Modern Set Analyzer. Resistance values to a megohm, current to 0.5-A., and potential to 1000 V. are read on one meter.

HOW TO MAKE AND OPERATE AN ULTRA-MODERN SET ANALYZER

Details of a valuable service tool. Only one meter for internal and external set and tube tests. Ranges: 1 ohm to 1 megohm; 5 to 1000 V., A.C. or D.C.; 1 to 500 ma., A.C. or D.C.

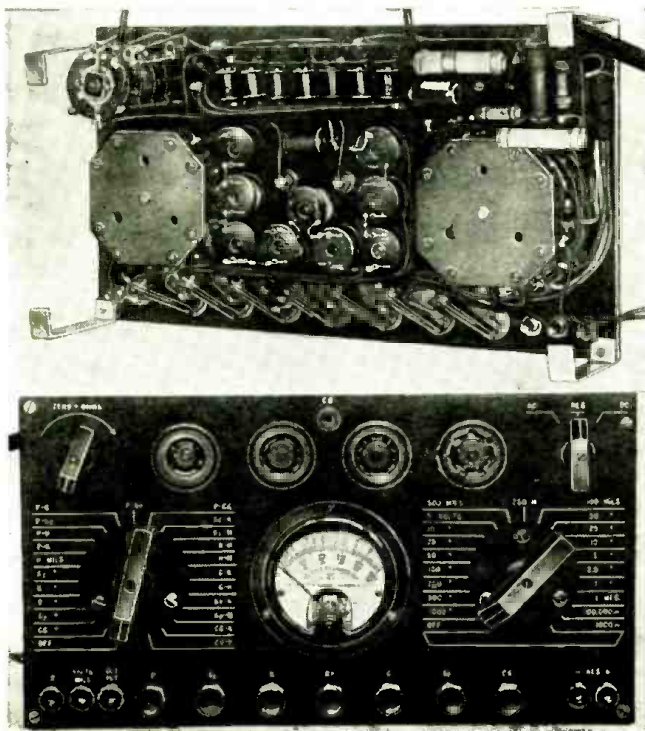

Fig. A

Above, rear view and, below, front view of the analyzer.

CHARLES SICURANZA

THERE are, at the present time, many good set analyzers on the market. All of them possess some good feature, and also some particular feature which is not so good. Some are too bulky or too heavy to carry around; some have inadequate meter ranges; some are too frail to stand the abuse of constant service, etc.

After having tried seven commercial makes of analyzers in the past four years, learning, through the medium of testing and repairing over 4,000 sets, just what an analyzer should and should not do, the author decided to develop his own. The completed instrument, illustrated in Fig. A and shown by diagram in Fig. 1, possesses the following features:

Only one meter to read.

Voltage and current tests on all tube elements.

Point-to-point resistance tests using the analyzer cable, with a resistance range of 1 ohm to 1 megohm.

All tube elements can be measured with a variable range of 5 V. to 1000 V. on A.C. or D.C.

All tube elements (except heater) can be measured for current with a variable range of 1 ma. up to 500 ma.

All ranges are available externally through 5 pin jacks on the analyzer panel; 2 jacks are used for resistance measurements.

No external batteries are required for the high-resistance range.

The output range is from 5 V. to 100 V.; the meter is isolated from D.C. by a condenser.

(Continued on page 425)

Recently granted patents are here described for wide-awake radio men.

NEW PATENTS

1,920,194. Frequency Multiplier
This is a frequency multiplying arrangement composed of a device to which a transmitted frequency is supplied, having a number of stages connected in "cascade" and each stage including an amplifier, a frequency multiplier (requiring a minimum amount of energy for its operation, connected to the output circuit of the amplifier) and an interference eliminator coupled to the output of the circuit of the multiplier and suppressing practically all frequencies except a harmonic of the frequency impressed on the input of the multiplier.

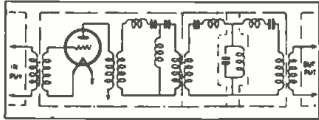

1,920,576. Combined Amplifying and Rectifying System

A rectifying and amplifying circuit including an audion having grid and plate electrodes, a two-part cathode emitter and a heater for the emitter (the heater being adapted to be connected directly to a source of A.C.) a high resistance connected across the heater, an input circuit including the grid which is connected to the approximate center of the resistance, a connection between the two parts of the cathode including a high resistance and an output circuit including a connection from the plate to the approximate center of the second resistance, whereby the A.C. is fully rectified and applied to the plate.

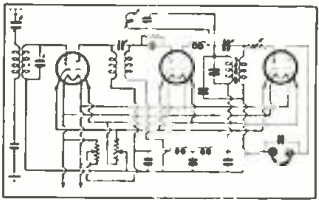

1,921,226. A Circuit for Balancing Out Internal Noises

A vacuum tube signal receiving system having an R.F. amplifying section, a detector stage and a resistance-coupled A.F. amplifier; the amplifying units having a common plate circuit return including a relatively low resistance and the detector stage having a plate circuit return including a relatively high resistance. In addition, a device for supplying the plate circuits and with D.C. which is subject to occasional variations and which tends to create disturbing variations in the plate circuits; and a means for causing the variations applied to the

*Compiled by Patent & Technical Information Service, Washington, D.C.

earlier stages to be carried forward through the interstage couplings, thereby affecting the grids of the later stages in such a way that the opposing effects bear such relation to one another that disturbing variations in the output circuit are substantially eliminated.

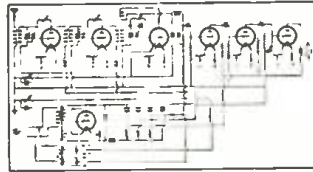

1,920,665. Symmetrical Loop Receiver

A method of developing oscillations consisting of balancing the oscillations in a loop by dividing the loop into symmetrical circuits, conducting the oscillations from either side of the loop to an element of a vacuum tube and bypassing part of the oscillations to a different element of another tube, whereby the local oscillations set up by either tube are neutralized.

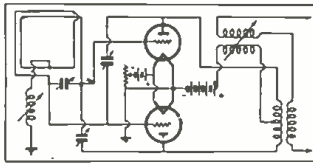

1,921,117. Wavemeter for Ultra-Short Waves

A micro-ray wave meter containing two sections of transmission line of fixed length and a section of transmission line of variable length between the two fixed sections, in which for the range of frequency to be measured (the characteristic impedance of the variable length section is large compared to that of either fixed length section. The length of the intermediate section is adjustable to indicate the length of the wave being measured.



1,922,290. Detection of Frequency-Modulated Signals

A system for detecting frequency-modulated waves comprising a pair of vacuum tubes each having an anode, a cathode and a control electrode; a reactance connected between the control electrode and cathode of each of the tubes, a long transmission line coupled to one of these reactances for causing one of the tubes to operate at a frequency to one side of a mean desired

operating frequency; another long transmission line coupled to the other reactance for causing the other electron discharge device to operate at a frequency on the other side of the desired mean operating frequency; coupling between the tubes so that they operate at the mean operating frequency, and provision for applying frequency-modulated signals to the tubes, rendering them relatively more or less conductive in accordance with the frequency of the signals.

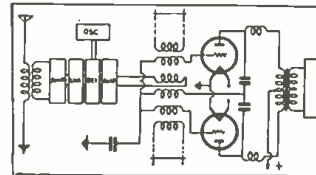

1,921,476. Relaxation Oscillator and Amplifier System

An oscillator system for generating electrical oscillations containing a thermionic tube having a cathode, an anode, an inner grid, a central grid and an outer grid; a circuit arrangement including impedance elements interconnecting the cathode, anode and central grid and outer grid for the generation of oscillations and a device for supplying a biasing potential to the inner grid to prevent the tube from operating at the point of saturation.

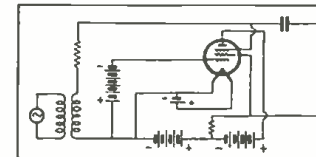

1,921,501. Piezoelectric Oscillation Generator

A generator of electrical oscillations comprising a piezoelectric element and support, an amplification system and a magnetic reproducer. The latter is acoustically coupled to the piezoelectric element for applying sound impulses against the piezoelectric crystal element in synchronism with the electrical impulses generated by the piezoelectric element, for reinforcing the vibrations of the piezoelectric crystal frequency.

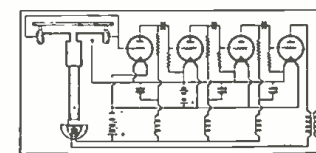

1,924,803. Loudspeaker

An acoustic diaphragm composed of loosely woven material having its interstices filled with a stiffening agent and having its

surface covered with a mixture of powdered metal and finely divided graphite in a suitable binder.

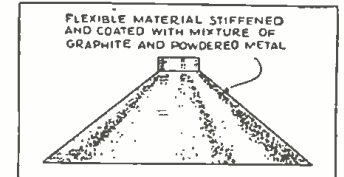

1,922,008. A Novel Floor-Mount Radio Set

A portable radio receiver in a cabinet setting directly on the floor; a tuning device in the container, controlled by an extended knob positioned above the container at a level convenient for the hand of a person standing, sitting or reclining. The tuning controls are located in an extension projecting above the cabinet, of substantially less cross-sectional area than the cabinet. An enlargement at the upper end of the extension contains an indicating dial.

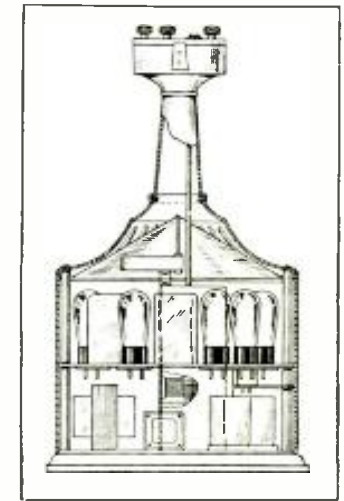

A NEW DEPARTMENT

Patent specifications disclose to the trained investigator many profitable ideas. However, they are couched in terms that confuse the average technician.

RADIO-CRAFT therefore has arranged to present in these columns lucid excerpts of interesting patents that have been recently granted.

Inquiries concerning patent law, etc., are invited.

MAKING— A DIODE MULTIMETER

BERT BETHIANY, JR.

FEATURES:

MEASURES A.C. (R.F.) 0 to 0.5- and 5 milli-amps. Most technicians ages from 0 to 500; have all the necessary and current values from components on hand.

Detailed directions for building a multi-meter with a sensitivity of about 5,000 ohms per volt. This design permits accurate voltage readings to be obtained in operating high-resistance circuits.

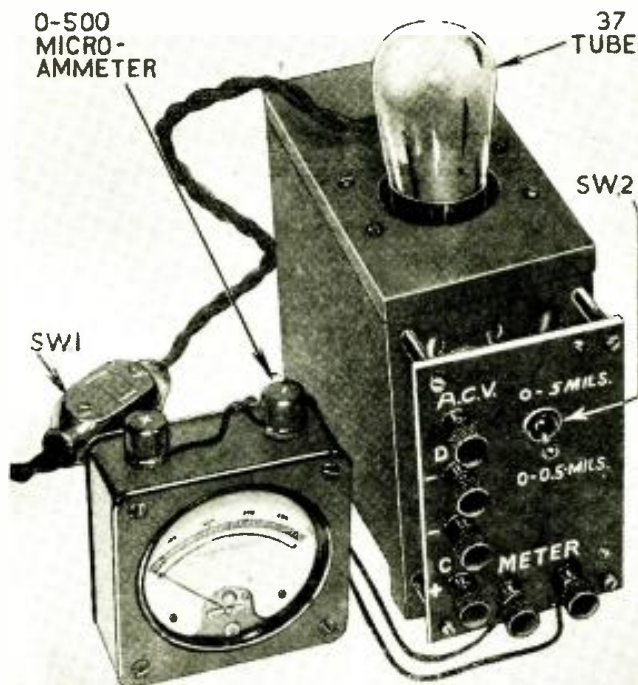

Fig. A
View of the "5,000 ohms per volt" meter.

THIS instrument measures A.C. voltages from 0 to 500 V.; D.C. voltages from 0 to 500 V., and direct current from 0 to 0.5- and 5 milliamps. (the former figure may be taken as 500 microamps., and the latter, 5,000 microamps.)

For D.C. voltages, the meter imposes a constant load of 1. megohm on the circuit being measured. This is about 5,000 ohms per volt at ordinary radio set voltages of 200 or 250 V. For A.C., the load is approximately $\frac{1}{2}$ the value of resistor R, that is $\frac{1}{2}$ -megohm.

The instrument, shown in Fig. A, is accurate, easily built, and the parts cost only about \$12.00.

In the D.C. section, an accurate meter and resistor measure directly the voltage or current, as shown in Fig. 1. In the A.C. part, this same resistor and meter used with a type 37 tube form a diode rectifier type of meter. The diode current read on the meter is directly proportional to the A.C. voltage impressed on diode-connected tube V1.

Construction

The case and the filament transformer were taken from an old 90 V. "B" eliminator, found in the junk box. The case measures 6 x 6 x 3 ins. wide and contains the 37 tube and socket, the condenser, C, and the transformer. Only the primary and filament windings of the latter are used.

On the 3 x 5 in. bakelite panel, which is separated one inch from the case by four pieces of brass tubing, are mounted the shunt resistor R2 and its switch Sw2, the diode resistor R1, the mica condenser C2, which is used to bypass

any inductive effect of C, at R.F., and the binding posts. The portable 0 to 500 microampere meter is connected to the two binding posts at the bottom of the panel. The panel layout and a graph for A.C. readings are shown in Fig. 2.

The binding post marked + Com. is common for all readings and is positive for D.C. readings. The 37 tube is used for A.C. readings only.

The meter shunt resistor, R2, is a 10 ohm filament resistor. It is adjusted by connecting a .1-meg. resistor in series with a 45 V. "B" battery, to the - I and + Com. posts; the reading should be about 450 microamps. Switch Sw2 should then be thrown to the 0 to 5 ma. position and the shunt resistor varied until the meter reads 1/10 of its former value; the resistor is then fixed at this value.

Incidentally, when reading voltages which *might* be greater than 500 V. be sure to get the reading first on the 0 to 5 ma. range, then switch to the lower range.

With the input connected to - D.C.V., and the switch, Sw2, in the 0 to 5 ma. position, the meter reads 0 to 5,000 V.; the accuracy depends upon the care taken in adjusting the shunt resistor.

D.C. Readings

The D.C. voltage readings are exactly the same as the scale of the meter; that is, if the meter reads 130, the voltage is 130 V., etc.

The direct current readings are the same as indicated by the meter scale for the 0 to 500 microamp. range and are 10 times the scale reading for the 0 to 5 ma. range.

A.C. Voltage

The meter must be calibrated for A.C. voltages. This is done by connecting the binding posts marked A.C.V. and + Com. to the 110 V. A.C. line. A reading of 120 to 150 microamps. results, depending upon the tube used and the line voltage.

Since the line voltage is usually known or can be easily determined, then (Continued on page 419)

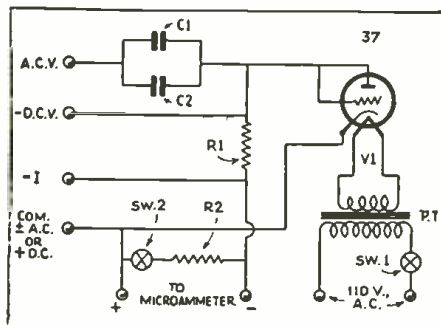

Fig. 1
Circuit of the diode-type multimeter.

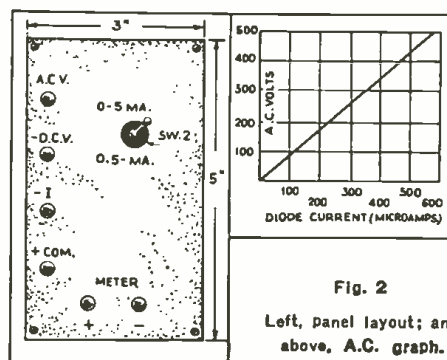

Fig. 2
Left, Panel layout; and above, A.C. graph.

A NEON-TYPE, METERLESS CHECKER

Past issues of RADIO-CRAFT have described meterless tube checkers, direct- or "English-reading" tube checkers, and the "column of light" design of neon tube and its characteristics, but it has remained for a progressive instrument manufacturer to market a service unit incorporating all of these new ideas. The height of a column of neon light indicates the relative worth of a tube.

C. H. HOCKNER*

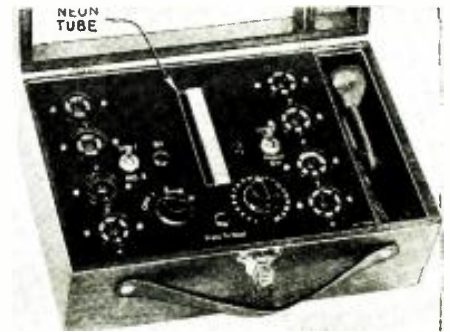

Fig. A
Front view of the "neon" tester.

RADIO Service Men as well as dealers have long felt the need of a reliable and accurate low price "English reading" tube tester which would withstand the rapid changes in tube specifications and numbers. To produce a tester to meet this demand, research was started months ago and resulted in the development of the neon tube as a means of testing vacuum tubes. The exterior and interior of this new tube tester are shown in Figs. A and B respectively.

This neon vacuum tube tester utilizes a special neon glow discharge lamp, operating on 2 to 11 ma. at 86 V., to indicate the value of tubes, instead of using a meter. A column of light travels along the cathode of the neon tube much in the manner of a thermometer and an accurate reading is obtained from a vertical, "English reading" scale. Different voltages are applied to the eight sockets through a simple switch arrangement and a variable shunt resistor set at predetermined points, according to the tube to be tested as shown in Fig. 1. This enables the tester to give an "English reading" test to tubes up to and including the 25 V. series. This arrangement makes it possible to test the many tubes in present use, and in addition, tubes to be developed in the future.

Operation Methods

Socket No. 1 is used to test all triode tubes and socket No. 2, all rectifiers. In the plate circuit of socket No. 2, a 1,500 ohm resistor is placed to equalize the "English reading" circuit as the rectifier tubes have a higher current drain. Each plate of the rectifier tube is tested by tying the grid and plate of this socket to a single-pole double-throw switch Sw.7. Socket No. 3 checks five prong tubes, a switch, Sw.1, is provided to return the cathode to ground or to plate, to check pentodes, type 33 or 47. An additional switch, Sw.2, ties grid to plate to check all screen-grid and R.F. pentode tubes. Socket No. 4 is used to test duodiode, class B and all full-wave

detector tubes such as Wunderlich and KR22. The same switch which is used to tie cathode to plate is ganged with another switch to tie plate to cathode, and suppressor to ground potential. Socket No. 5 is used to test all 6 prong pentodes where control is returned to a prong at the base. Socket No. 6 checks all 6 prong R.F. pentodes which have the control-grid at the top. Socket No. 7 is for all small base 7 prong tubes and socket No. 8 is also a 7 prong socket taking the large base 7 prong tubes such as 59 and Arcturus PZH.

The power transformer is tapped for the following voltages: 1.5, 2.6, 6, 12, and 25. Any of these voltages may be applied to the various sockets through a 5-position control switch, Sw.3. A 230 V. winding is provided for plate voltage. "English reading" is obtained by a variable shunt resistor across the neon tube.

To check leakage between filament and cathode an additional single-pole single-throw switch of the push-button type is provided. One pole of this switch connects to all cathodes and another pole to ground potential. If, on breaking this switch, the neon tube still glows it shows filament-cathode leakage.

(Continued on page 439)

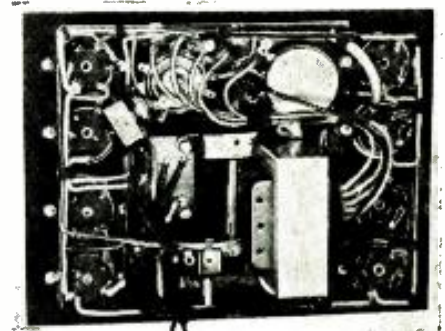

Fig. B
Interior view. Note neon tube.

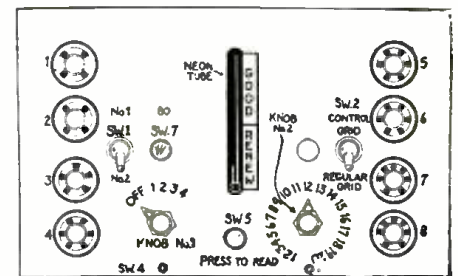

Fig. 2
Panel lettering. Refer to Table 1.

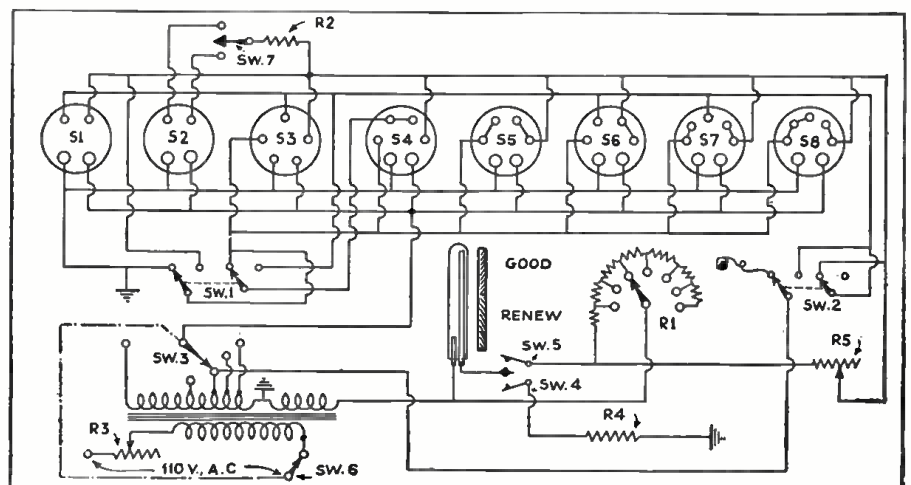

Fig. 1
Diagram of the new neon-type, meterless tube checker.

*Engineer, Acme Mfg. Co., Inc.

MIDWEST MODEL 16-34 SUPER-DE LUXE 16-TUBE ALL-WAVE SUPERHETERODYNE

(Incorporates 5-band reception from 9 to 2,000 meters; interstation noise suppression; amplified A.V.C.; and "select-o-band" tuning.)

This superheterodyne operates at an I.F. of 450 kc. The amplifier is peaked on output developed in A.F. and not on A.V.C. voltage as customarily used. The tube layout is shown in detail A.

The A.V.C. amplifier transformer, the small single tuned transformer, is peaked at minimum trimming, bearing in mind that the local station used is not too powerful to ride over the A.V.C. action.

The R.F. amplifier and mixer adjustments are also made on the A.F. output.

Tone control action is as follows:—due to the automatic tone compensation in the receiver the tone control has little effect at low volume levels, but is very effective at high volume. The tone at low volume is taken care of automatically.

To align the "A" circuit, tune on the "A" broadcast band to some weak, distant station in the region of 1,450 kc. Adjust trimmers marked "A" band trimmer in the R.F. section, and "A" band trimmer in the mixer section, shown in detail illustration B, until the station comes in with maximum volume.

The values of the components are as follows:

C1A, C46, C47—250 mmf.; C1, C11, C23—80 mmf.; C2, C3, C8, C9, C13, C21, C38, C40, C42, C43, C45, C49, C49A, C49B, C50, C51, C54, C57, C59, C61A, C63—80 mmf.; C4, C5, C6, C12, C14, C16, C19, C24, C25, C26—0.5 mf.; C7, C20, C28—365 mmf.; C10, C18, C43A—25 mmf.; C22—1-mf.; C29—160 mmf.; C30—320 mmf.; C31—720 mmf.; C32—0.03 mf.; C33—500 mmf.; C34—0.02 mf.; C36—0.4 mf.; C52—0.1 mf.; C53, C55—25 mf.; C53A—10 mf.; C56—12 mf.; C58—1 mf.; C61, C62—0.01 mf.; C64, C65, C66—8 mf.; C67—25 mf.; R1A, R3, R12, R14, R17, R22—5,000 ohms; R1—75,000 ohms; R2, R8, R13, R16—2-meg.; R4, R20, R30, R32, R32A, R40—50,000 ohms; R5, R11, R34—15,000 ohms; R7, R23, R26, R27, R27A, R29—5-meg.; R9—1,000 ohms; R10, R33, R38—10,000 ohms; R12A, R24, R25, R27B, R39—1-meg.; R15, R18—3 meg.; R19, R36, R36A—52,000 ohms; R21, R21A—4,000 ohms; R28—5-meg. Volume Control; R31—700 ohms. Tube operating voltages are as follows:

Tube Type	Plate Volts	S.-G. Volts	Sup.-G. Volts	C.-G. Volts
V1	240	125	..	5+ A.V.C.
V2*	230	50	3
V3	125
V4	230	60	..	5+ A.V.C.
V5	230	125	..	5+ A.V.C.
V6	230	125
V7	-20	-20
V8	0
V9	170
V10	170
V11	170
V12	240	60
V13	240	60
V14	240	60
V15	240	60
V16	375

(* Suppressor-grid voltage, V2. 3 V. Readings taken with Stat-o-mit and volume control full on.

The "E" band. The lower center knob is the band selector. When the switch is in the extreme left position, the band covered will be about 150 kc. to about 730 kc. This band includes the European long-wave stations, ships, aviation and weather stations.

"A" Band. When the switch is rotated one notch to the right the band covered will be from 530 to 1,500 kc. This is the regular American broadcast band.

"L" Band. If the switch is rotated into the third position the range will be from about 1.5 to 4.1 megacycles, covering police, amateurs, television and airplane stations.

"M" Band. With the switch in the fourth position the range will be from about 4.1 megacycles to 11.7 megacycles. This covers the commercial, foreign amateurs, American, Canadian and South American stations.

"H" Band. When the switch is rotated to the extreme right, the band will be from about 11.7 to 33 megacycles. This covers amateurs and ultra-short-wave stations.

The procedure in reducing any slight background that may be heard is to slightly twist T1 on its single bearing, as shown in illustration C.

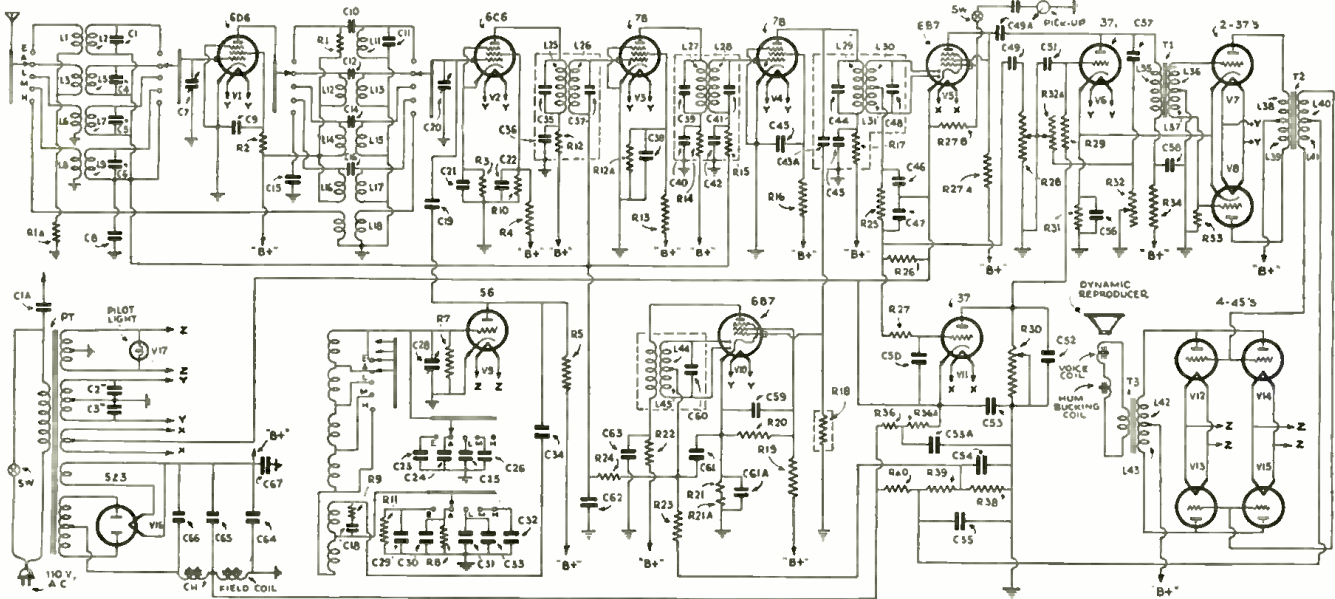
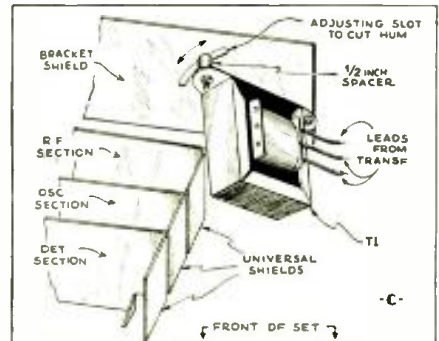
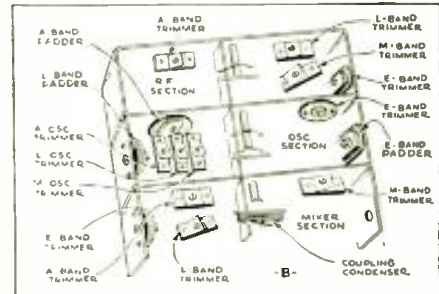
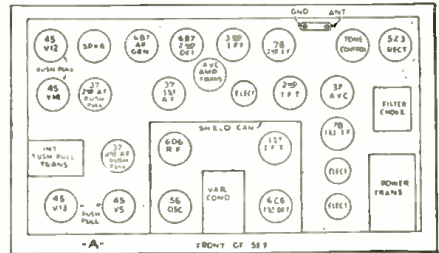

KADETTE MODELS A AND B, 5-TUBE A.C.-D.C. SUPERHETERODYNE

(Incorporates short- and broadcast-band reception; A.V.C.; uses the new tubes 6A7, 6B7, 6D6, 43 and 25Z5.)

Tube operating voltages for this set are given in the detail illustration. The cabinet of the model A set is of molded bakelite; the model B receiver, illustrated, is made of wood and on the style of one of the structures at Chicago's Century of Progress.

The components have the following values: Condenser C3, 16 mmf.; C5, 730 mmf.; C6, C7, C8, C9, .15-, .05-, .05-, .006-mf., in one condenser block; C12, C17, C21, C22, .15-, .05-, .05-, .006-mf., in one condenser block; C15, C16, 350 mmf.; C18, .003-mf.; C19, C20, .01-, .08-mf., in one block; C23, 24 mf.

Resistors R1, R7, R9 (volume control), .25-meg.; R2, R5, 50,000 ohms; R3, 140 ohms; R6, R10, 1 meg.; R8, 50,000 ohms (tone control); R11, 160 ohm power cord; R12, 20 ohms.

Low sensitivity is generally caused by a poor 6A7. Microphonic howl and tendency to overload or be critical in tuning may be caused by the 6B7. Low plate voltages where there is no defect in the set indicate a weak 25Z5.

Greatest sensitivity and volume are obtained when a slight amount of regeneration is introduced. This is controlled by altering the position of the braided shield covering the 6D6 grid wire.

The I.F. is 262.5 kc.; align the broadcast band on 550, 1000 and 1,500 kc. A weak signal is necessary to get below the action level of the A.V.C. circuit.

Since this model uses an A.V.C. tube it is impractical to use the conventional A.C. output meter in the output circuit when balancing the set. Instead, a microammeter with a range up to 50 micro-A. is required to measure the bias potential applied by the A.V.C. tube to the 6D6 I.F. amplifier. A 1 meg. variable resistor is placed in one of the leads of the meter. The positive lead is fastened to the ground which is the rotor plates or frame of the variable condenser while the negative lead is attached to the mid-point of the secondary of the second I.F. (the bottom connection of the volume control). To align the I.F. units, connect the test oscillator output wire to the grid of the 6A7 tube. The positive lead of the meter is to be inserted between the plates of the oscillator section of the variable condenser in such a manner as to short out this condenser so that the oscillator is not operating; this is the section nearest the

rear of the set. Tune the service oscillator to 262.5 kc. and, with the volume control full on, adjust the four nuts at the ends of the I.F. units.

To align the 2-gang variable condenser on the broadcast band first be sure the switch in the rear of the set is turned to the long wave, i.e., broadcast, side. Remove the positive lead of the meter from between the plates of the oscillator condenser and attach it to the frame of the variable condenser. Remove the service oscillator output wire from the 6A7 grid clip and attach it through a 100 mmf. fixed condenser to the antenna wire. With the service oscillator set at 1500 kc., open up the variable condenser until maximum reading is indicated on the micrommeter. Adjust the trimmer on the antenna section of the variable condenser until maximum reading of the meter is indicated.

Next, turn the service oscillator to 550 kc. and move the condenser slightly back and forth while tightening or loosening the screw which adjusts the output to the point of highest indication on the meter. When this has been found, rock the condenser slightly back and forth while tightening or loosening the screw which adjusts the series padding condenser on the end of the oscillator coil. By tightening or loosening this screw the series capacity of the oscillator can be so fixed that the antenna and oscillator circuits are correctly matched.

Finally, reset the service oscillator to 1,000 kc. and, with a thin bakelite, celluloid, or mica feeler strip inserted between the plates of the variable condenser determine whether the circuits are correctly matched (the change in dielectric value changing the

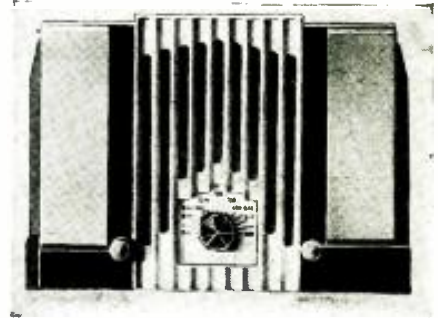

resonance of the circuit). This method should be used on both circuits. This can be corrected by bending the outside rotor plates outward at the point where they enter the stator. If it has been necessary to bend plates at the 1,000 kc. setting, it will be necessary to re-check the 550 kc. setting.

To adjust the short-wave section, snap the switch in the rear of the set to the short-wave position. Select a harmonic of the service oscillator which is found with the rotor condenser plates in approximately the same position found while the set was being aligned at 1,500 kc. on the broadcast band. Adjust the small trimmer condenser attached to the short-wave antenna coil until maximum reading of the micrommeter is obtained. Next, select another harmonic of the service oscillator which will be found with the rotor plates of the variable condenser at about the same position that was experienced at the 550 kc. test of the broadcast band. Check the alignment with the "dielectric feeler." If the antenna stage appears to have too little capacity, it will be necessary to spread very carefully one or two turns of the short-wave winding of the oscillator coil. (This is the narrow winding next to the padder on the oscillator coil; use extreme care in handling this stage of the service.) On the other hand, if the antenna section appears to have too much capacity, a few turns may be spread on the short-wave antenna coil.

Do not change the adjustment of the trimmers on the condenser gang or the padding condenser on the oscillator coil when checking on the short-wave position.

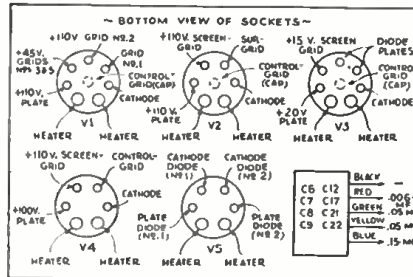

The operating voltages on the 5 tubes.

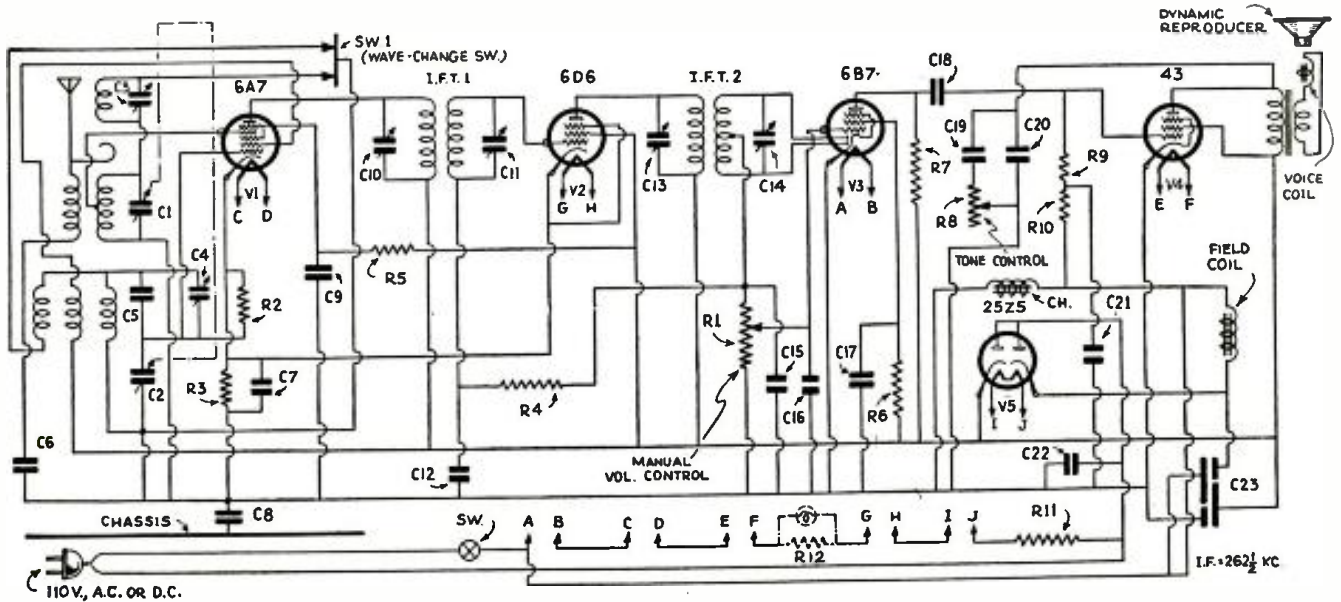

THE ANALYSIS OF RADIO RECEIVER SYMPTOMS

OPERATING NOTES

VICTOR SETS

RECEIVERS of late 1931, '32 and early '33 vintages have by this time given normal use and are showing amazing regularity in their breakdowns.

The Victor Micro-Synchronous models R-35, 39 and 57 are showing two defects. The first is fading and low volume on radio reception in models 35 and 39. In the model 57, the record reproduction and home recording show O.K. but radio recording and reception do not. This is due to the failure of the 1½-megohm resistor in the screen-grid circuit of the detector tube. This condition can be checked by pulling out the tube which is inclosed in the shield nearest the phono. terminal strip at the left side of the chassis from the rear. When this tube is reinserted the radio signal will appear and then fade; presto, half your call is then completed. The faulty 1½-meg. resistor is colored white with

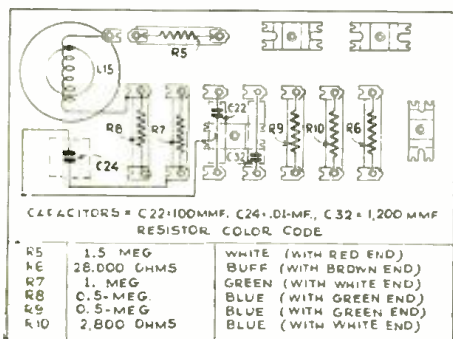

Fig. 1

Resistor R5 causes failure of the receiver.

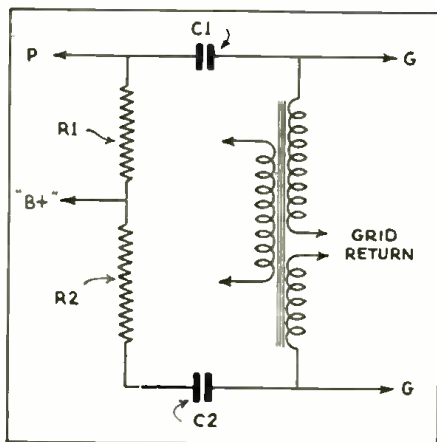

Fig. 3

Circuit of the repaired input transformer.

a red end, and can be found on the under-side of the terminal strip, as illustrated in the R.F. section of the chassis, between the R.F. and detector sockets.

Another common failure in receivers

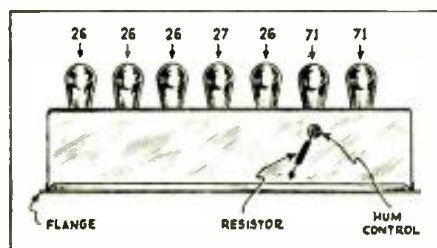

Fig. 4

A common fault in Majestic model 70 sets.

of these models display the same symptoms—with the exception of the fading—is the breaking down of the 7,000 ohm resistor. This resistor, color coded green and red, is connected to terminal posts one and seven of the filter block in the power unit.

While on the subject of Victor, it would be well to mention the RE 45 which is the old 10 tube job using 26's. Complaints of noise while tuning are quite common and can be traced to the The original connections to ground are copper strips used for rotor contacts. loose and turning the dial causes the strips to make a better connection, resulting in noise. Faulty record reproduction together with noticeable blasting (on base notes in particular) are usually caused by a worn-out rubber damper in the pickup head. This damper can be replaced at a cost of three cents; it is Victor part No. A605.

(Continued on page 440)

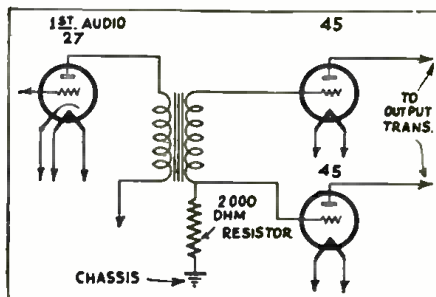

Fig. 5

An ordinary A.F. transformer restores service in case of P.P. transformer break-down.

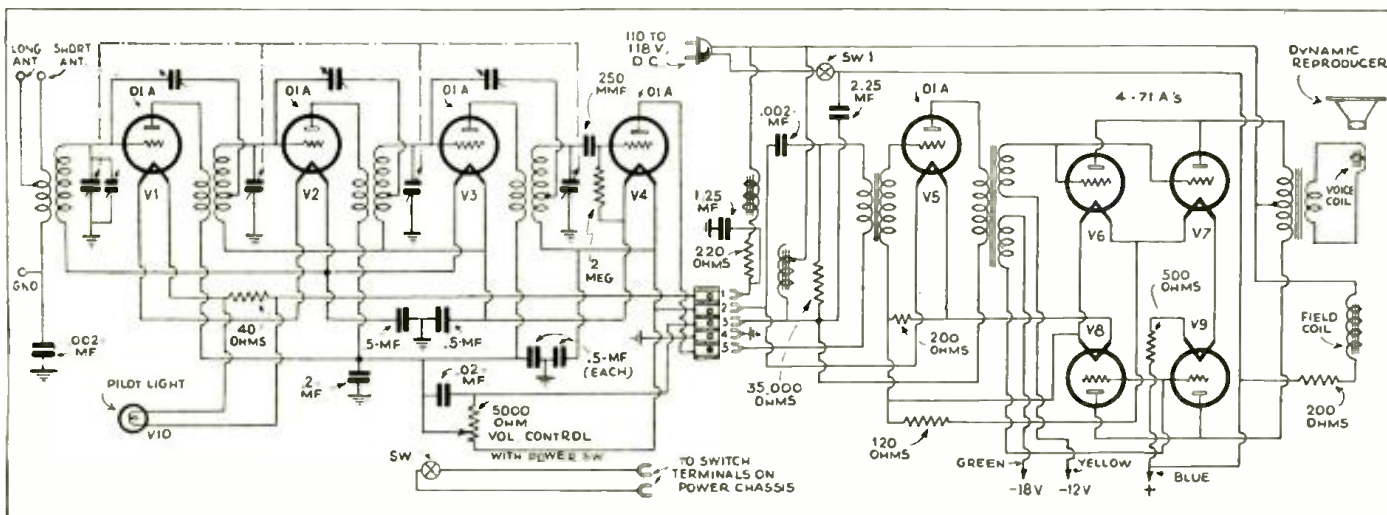

Fig. 2

The circuit diagram of the Brunswick DC-14 and DC-21 receivers. The input transformer to the push-pull 71 tubes causes trouble.

THE RADIO MONTH IN REVIEW

(Continued from page 3011)

the professional musician. What possible encouragement is there under such conditions for a youth to study music with a view to making it his profession?

"Before radio, people bought music in large quantities. They no longer use their pianos—they 'listen in.' Sales of sheet music, by three leading firms, whose records indicate the trend in the whole trade, have decreased from a peak of \$3,447,775 in 1926 to \$827,154 in 1932, a decline of 75 per cent, because of the radio use of music.

"Before radio song hits had an average sales life of 16 months. People heard a song in theatres and music stores and bought copies of the sheet music. An outstanding song hit would sell at the average rate of 1,156,000 copies.

"Then came radio. The composer's income from the sale of sheet music and phonograph records declined. Always on the lookout for something new, radio seizes each new hit, plays it to death in a few weeks and then—CRASH! The total sale for even an unusually outstanding song hit now averages about 223,000 copies."

We propose to refute the unreasonable claims of the "big bad wolf" ASCAP, in four statements.

(1) Broadcasting has not lowered the level of music appreciation. On the contrary, it is an accepted and proven fact that broadcasting has introduced musical appreciation and education to more people than any other single factor. Just let Gobbman's band, John McCormick or any other popular orchestra or artist fail to appear at a scheduled broadcast and we would like to present the ASCAP with the job of answering the letters of protest and inquiry that literally flood the broadcasting stations from all parts of the country—large cities, towns, villages and isolated farms. And we challenge the ASCAP to belittle some of the orchestras and musicians in our grade schools and high schools!

(2) No one—and we include the broadcasters—wishes to have our talented composers starve on our hands, or even receive less than fair compensation. The National Association of Broadcasters (otherwise known in back of the mike as "NAB") is quite aware of the fact that they need music—new, old, popular and classical—to keep up the interest of John Public in the reception of radio programs. And it is natural that they would not do anything deliberately to hurt our musical geni. But—the NAB represents a group of serious minded business men who have to be convinced that the composers and authors are not receiving fair recompense for their work before they will boost it to the extent demanded by ASCAP.

Also, ASCAP cannot hold the broadcasters responsible entirely for their depleted coffers. Everyone has suffered financial losses in the past few years and while broadcasting may have been a contributing factor, there are a multitude of contributing causes for the reduction in the sales of sheet music.

(3) And we refute the statement that the lack of "gold mines" in return for musical compositions or their renditions will "scare" talented young people from professional music.

Talent will voice itself regardless of the recompense. How about the composers of past years? Many of the best that the world has known have lived and "produced" in extreme poverty. It did not "cheapen" their work as the ASCAP claims it will.

While intelligent Americans would not wish musicians and composers to receive less than fair recompense for their efforts (we are able and willing to support our talent) we are the first to resent any misstatement of facts.

(4) The ASCAP booklet states that radio is responsible for the reduced remuneration to composers due to the fact that a new composition is "played to death" in three months. Have the composers considered the fact that quantity production reduces cost? In the days when 1,156,000 copies of a composition were sold, considerably fewer compositions were published yearly!

Fascinating new Game!

Have the fun . . . thrills . . . adventure of a

RADIO TOUR



A "First Night" in Hollywood—get the thrill of it on a Radio Tour!

Sioux Indians in the Black Hills stage a primitive tribal dance—what an adventure on a Radio Tour!

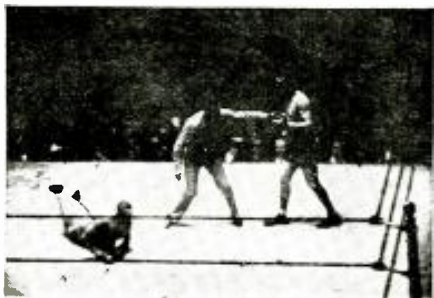

"Ringside" at Madison Square Garden . . . be there for the big fights—on a Radio Tour!

Ride your Radio to the Mardi Gras . . . get all its glamour and color touring via Radio!

Throw out old, worn-out radio tubes . . . re-tube with new Cunningham or Radiotrons—get in the game!

HERE'S a chance to get in on the greatest game ever devised for radio set owners! Don't confine yourself to five or six stations . . . there are more than 650 to choose from . . . Go on a Radio Tour! A turn of the dial and you're touring North America! Drop in

good radio set, with a good antenna system—plus a new set of Cunningham radio tubes or RCA Radiotrons. Don't be held back by worn, "stick-in-the-mud" tubes. Step out tonight with the world's finest—the only tubes guaranteed by RCA . . . built with 5 great new improvements undreamed of when most people bought their tubes. To make it easy for you, we'll send you a large 4-color "Radio Tours" map showing at a glance all the radio stations in the United States, Canada and Mexico, with call letters and kilocycles . . . And the remarkable new "Radio Set Performance Yardstick" devised by RCA and the Cunningham engineers. It tells you whether your set is in excellent, good, fair or poor operating condition. Get this exciting booklet "Radio Tours" with the new "Radio Set Performance Yardstick" from your dealer or send 10c in stamps to cover handling and mailing to RCA Radiotron Co., Camden, N. J.



RCA Cunningham Radiotron

Please send your illustrated folder "Radio Tours" with station map and "radioyardstick". I am enclosing 10c in stamps for postage and handling.

Name

Address

(Coupon must be sent to RCA Radiotron Co., Camden, N. J.) 29



RADIO-CRAFT'S INFORMATION BUREAU

SPECIAL NOTICE TO CORRESPONDENTS: Ask as many questions as you like, but please observe these rules:

Furnish sufficient information, and draw a careful diagram when needed, to explain your meaning; use only one side of the paper. List each question. Be SURE to sign your name AND address.

Those questions which are found to represent the greatest general interest will be published here, to the extent that space permits. At least five weeks must elapse between the receipt of a question

and the appearance of its answer here.

Replies, magazines, etc., cannot be sent C. O. D.

Inquiries can be answered by mail only when accompanied by 25 cents (stamps) for each separate question; answers are subject to subsequent publication, if considered of exceptional interest.

Other inquiries must be marked "For Publication."

DEPENDABLE TUBE TESTER (A Correction)

(226) Mr. N. L. Putnam, Elizabeth, N. J.
(Q.) I have constructed the Dependable Tube Tester described in the August, 1933 issue of RADIO-CRAFT, on page 86.

However, I have encountered some trouble with the unit, and wish you would assist me. There is no connection provided for the control-grid cap for tubes which require this connection; and also, you will find that the circuit connected with point 5 on section 1 of the multi-tap switch is not "live." In other words if you check the latter circuit, there is no possibility of getting current to this contact and the corresponding connections on sections 2 and 3 of the tube selector switch. What do you advise?

(A.) Upon checking the wiring diagram of the unit, we find that Mr. Putnam is correct—there are two errors in the diagram of this test unit. To assist those who have constructed the unit, we are printing here a section of the diagram in which the errors are found. See Fig. Q.226. This partial diagram has been drawn in exactly the same proportions as the original.

AN ANALYZER METER

(227) Mr. Paul A. Jacques, Springfield, Mass.

(Q.) The October, 1933 issue of RADIO-CRAFT contained an article which is very interesting to me. I refer to the "modernized" version of the RADIO-CRAFT Universal Analyzer originally described in the September, 1932 issue.

My intention is to build one of these analyzers. However, the meter which I have is a type 301 (Weston), 0—25 ma. scale. In order to use this meter, it will be necessary to

have other values than those called for; or to change the shunt in the meter to correspond with that in a 0—1 ma. meter.

The question is, which is the better method of procedure; and what are the values of shunts and multipliers to be used, or the value of shunt to be put in the meter?

(A.) The meter that you have cannot be used in any practical set tester. The fundamental unit in a 0—25 ma. meter is not sensitive enough to indicate 0—1 ma. In other words, for 0—25 ma. the manufacturer can construct a more rugged meter and use either no shunt or a high-resistance shunt—and this movement cannot be made to indicate very small currents over the entire scale.

It will be necessary for you to obtain a 0—1 ma. meter if you desire to build the RADIO-CRAFT Universal Analyzer.

TUBE-TYPE HEARING AIDS

(228) Mr. F. H. Hawkins, Los Angeles, Calif.

(Q.) I am interested in building an amplifier unit for use with a small mike and phone for a customer who has difficulty in hearing. This unit must naturally be small in size and light so that it can be carried around.

Can you supply me with a suitable diagram and circuit constants for constructing a practical unit of this type?

(A.) The demand for better and cheaper "hearing aids" has resulted in the development of several new vacuum tube circuits for this purpose, of unusual power and sensitivity. Although the following data have been prepared by H. G. Cisin, especially for use with the products of Universal Microphone Products Co., instruments of other makes may be used provided the characteristics are the same—within practical limits. The battery circuit shown in Fig. Q.228A employs a single-button microphone, 1; four pin jacks, 2, 3, 10, 11; one 4-prong socket; one type 30 tube; one input transformer, 4; one 1,000 ohm phone, 12; one 400 ohm potentiometer, 6; and one 50 ohm rheostat, 7. Two small flashlight batteries, 8, supply both microphone current and the tube filament current, while a small 22½ V. "B" battery, 9, furnishes the necessary plate voltage. The equipment for this amplifier may be mounted in a case hardly larger than a Brownie camera. The microphone may be mounted either in the case

or may be used externally, being connected to the case by a long flexible lead.

Figure Q.228B shows an A.C.-D.C. hearing aid circuit. While this hearing aid is not portable in the strict sense of the word, it requires no batteries and may be plugged into any light socket, either A.C. or D.C., without requiring any changes in tubes or connections. The following parts are used: one single-button mike, 12; one input transformer, 11; two 5-prong sockets, 3, 10; two type 37 tubes; one 400 ohm 50 W. adjustable resistor, 2; two 4 mf. electrolytic condensers, 4, 6; one 30 hy. A.F. choke, 5; one 10,000 ohm resistor, 7; one 25,000 ohm potentiometer, 8; one 200 ohm resistor, 14; one 1,000 ohm phone, 13; and one 2 mf. condenser, 9.

The microphone used with either of these hearing aids must be light in weight and sensitive. Some of the "lapel mikes" are particularly well suited for this purpose.

CRYSTAL A.V.C. UNITS?

(229) Mr. C. M. Aldred, Indianapolis, Md.
(Q.) Why wouldn't it be possible to use a crystal detector in place of the usual vacuum tube for A.V.C. in superhets?

If you think the idea has possibilities, I would appreciate receiving a sketch of an experimental circuit which I could construct for use with my S.-M. super. (This set uses cathode bias control for manual adjustment.)

(A.) With reference to your inquiry, we do not think it is advisable to replace the A.V.C. tube in your set with a crystal detector. It is theoretically very sound, but practically it would never work out due to the fact that the "back resistance" of most crystals is not sufficiently high and also because most crystal detectors are not stable or will not carry sufficient current for I.F. tube bias.

COIL RESISTANCE—MIKE OUTPUT

(230) Mr. Clarence R. Miller, Lebanon, Pa.
(Q.1) What is the "gain" of a tuned circuit using a coil 3 ins. in diameter having 80 turns of wire and a winding length of 1 1/10 ins. operating at a frequency of 1,000 kc.?
See the article, "R.F. Coil Design," by C. W. Palmer, Part I, in the December, 1931 issue of RADIO-CRAFT, and Part II, March, 1932.

(A.1) There is no rigid mathematical formula on which the resistance of coils may

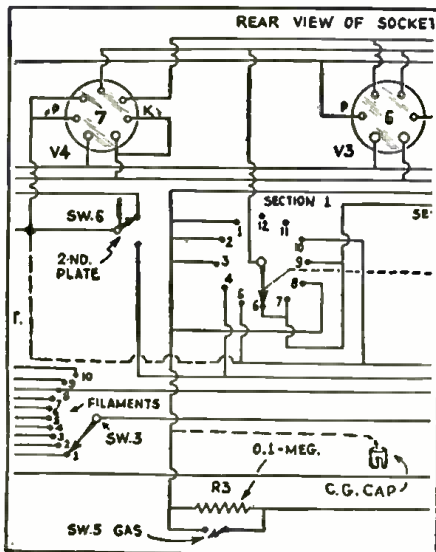

Fig. Q. 226
The corrections are shown dotted.

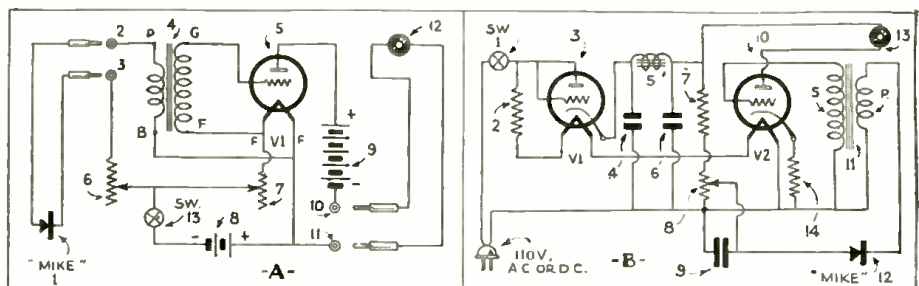

Fig. Q. 228

At A is a battery unit; and at B an A.C.-D.C. unit, for aiding partially deaf persons.

Service Engineers' 1934 REPLACEMENT TRANSFORMER

Catalog!

8 pages 8½ x 11"—fits your price manual or ready reference file. The most comprehensive catalog of replacement power supply units ever issued.



"U" FRAME



TYPE "P"

Any of the types illustrated for 4 to 12 tube sets, 110-120 volts 50-60 cycle, 115 volt 25-40 cycle and 220-240 volt 60 cycle.



TYPE "H"



TYPE "E"



TYPE "F"

"MULTI-TAP" (TRADE MARK)

UNIVERSAL TRANSFORMERS

4 UNITS FOR ANY OF 1377 MODELS

of radios. The Service Engineers' Emergency Stock (\$23.25 list) for promptly renewing original performance in case of transformer trouble in any of over 90% of all radios.

EXACT DUPLICATE—physically and electrically—power transformer replacements for 400 models of the popular sets.

Various Output, Interstage, Input Audios—shielded and unshielded single and push pull transformers.

Microphone and filament transformers and chokes.

Auto radio set replacement parts, test tube and step-down transformers.

GENERAL TRANSFORMER CORP.

502 South Throop Street
CHICAGO — ILLINOIS

Free for the Asking!
The 1934 GENERAL catalog, listing more than 400 models of power supply replacement units—fully illustrated, giving code word, shipping weight, dimensions, technical description and list price of each unit.

MAIL THIS COUPON TODAY!

GENERAL TRANSFORMER CORP.,
502 South Throop St., Chicago, Ill.
Please send me your 1934 catalog and address of your nearest distributor.

Name

Address

City..... State.....

be calculated with ease. Many of the formulas used for such purposes (refer to "Transient Phenomena," by Steinmetz) are extremely unwieldy and are not generally useful.

We might make a guess and state that the resistance of your coil is in the neighborhood of 6 or 7 ohms. (A more definite figure cannot be given in view of the fact that you do not state the size of wire with which the coil is wound.) You may also assume that the resistance of the coil increases directly with frequency.

(Q.2) If the output of a microphone is 37.34 db. "down," what is the value in milliwatts if the zero level is 6 milliwatts?

(A.2) The output power of your microphone which is 37.34 db. below zero level would be .0011-milliwatt. See the item, "Computation of Decibels," in the Information Bureau of the November, 1931 issue of RADIO-CRAFT.

SPEAKER CONNECTIONS

(231) Mr. E. E. Nelson, Baltimore, Md.

(Q.) I have obtained a Peerless 15 in. 110 V., D.C. dynamic speaker, but I am lacking directions for connecting it to the amplifier. Out of the side of the speaker project 4 wires, colored red, black, yellow and green. How are these to be connected into circuit?

In the lower back part of the speaker are 4 more posts, the two center ones being connected together.

(A.) The red and black wires of the speaker connect to the power supply in place of one of the filter chokes. This winding is designed to pass 40 ma. The yellow and green wires are connected in the bias circuit of the power tubes in place of the usual resistor (or in place of part of this resistor, if a high bias resistance is required). A high-resistance voltmeter or a milliammeter will tell when the power tubes are receiving the correct bias.

The four terminals that you mention are the output transformer connections to the

receiver. The two center ones are connected together. These two terminals (connected together) constitute the center-tap of the primary winding and in push-pull circuits are connected to the "B" supply for the power tubes. The two other terminals connect to the plates of the power tubes.

In the case of using a single power tube, either the two outer terminals or one outer post and the center-tap are used, depending upon the output impedance required for the power tube.

You should try reversing the connections to the two field coils (that is, those connected to the "B" supply and the power tube bias) to obtain the best results and the least distortion.

A DIODE TYPE MULTIMETER

(Continued from page 412)

on the calibration sheet a point is located, determined by the line voltage and the diode current reading. A straight line is drawn from the origin, through this point, and extending as far as it is desired to run the A.C. range (usually, 500 or 600 V. and the job is done.

This calibration is correct for voltages above a value of about 5 V. Below this voltage, due to diode characteristics, it is inaccurate.

(Voltages as high as 1000 V., A.C., have been measured on a diode meter of this type. But all 37 tubes won't stand this voltage; some of them are over in the tube base.)

When used as an output meter the leads are connected to the primary of the speaker transformer and not to the voice-coil leads.

The meter measures R.F. voltages and has been used to neutralize the amplifier stages in a transmitter; best neutralization being obtained when minimum R.F. voltage appears across the tank of the stage being neutral-

ized, when that stage's plate voltage is removed.

Additional shunts may be added to give any current range desired. The readings are accurate only if precision parts are used and all joints properly soldered.

List of Parts

- One paper condenser, 2 mf., 1000 V., C1;
- One mica condenser, .005-mf., C2;
- One resistor, 1, meg., 1 per cent tolerance, R1;
- One fixed filament resistor, 10 ohms, R2;
- One Westinghouse 0 to 500 microampere meter;
- One type 37 tube, V1;
- One 5 prong socket;
- One filament transformer supplying 5 to 6 V., P.T.;
- Six binding posts;
- Two switches, Sw.1 and Sw.2.

A FREE RADIO SERVICE COURSE

Radio Service Men and dealers in the metropolitan area will be interested in the announcement of a new service school for the benefit of radio technicians. This school has been started by the J. F. Distributing Co. of Brooklyn, N. Y. and National Union Radio Co.

A well-known instructor has been engaged and manufacturers of radio parts have made arrangements whereby their chief engineers will address the classes on new developments. There is no cost or obligation to those attending the classes.

Since the school was first announced privately to dealers and the New York area, the response has been beyond expectations. Over 200 men actively engaged in service work have requested enrollment.

The classes will be held every Wednesday evening at 9 P.M. The sponsors of the course believe that by setting this time, most men will be able to attend without any conflict with their working hours.

SHALLCROSS

Non-Inductive, Wire Wound
RESISTORS
PRECISION $\pm 1\%$



Made in any resistance from .1 ohms to 10,000,000. On special order the accuracy may be $\frac{1}{2}$ — $\frac{1}{4}$ — $\frac{1}{10}$ of 1%.

Get Genuine Shallcross
RESISTORS
from these distributors

Woodrow Radio Co. Cambridge, Mass.	M. & H. Sporting Goods Company Philadelphia, Pa.
Sun Radio Company New York City	Radio Specialties Co. Detroit, Michigan
Cameradio Co., Inc. Pittsburgh, Pa.	Walter Ashe Radio Co. St. Louis, Missouri.
The Radolek Company Chicago, Illinois	Wedel Company Seattle, Wash.
Spokane Radio Co., Inc. Spokane, Wash.	Radio Manufacturers Supply Company Los Angeles, Calif.
I. S. Cohen's Sons, Ltd. San Francisco, Calif.	
Leeds Radio Company New York City	

Send for Bulletin 117P—describing
Shallcross Resistors and
Test Equipment

SHALLCROSS MFG. COMPANY
Electrical Measuring Instruments
and Accurate Resistors.
700 MAC DADD BOULEVARD
COLLINGDALE, PA.

Give SERVICE

... with a Small Inventory

Here is the best Volume Control Proposition on the Market. Here are the reasons why?

- Over 400 "exact duplicate" controls in the "X" series.
- Yet with SIX controls in the original-AD-A-SWITCH-SERIES 477 sets can be serviced.
- By combining controls in both lines any requirement can be met with minimum stock investment.
- Clarostat with its two separate lines offers the widest range of controls to choose from.
- Clarostat Controls are inseparable from Quality Service Work.

Clarostat "X" line has over 400 controls to choose from—exact as to electrical overall resistance, taper, bushing, shaft length, and will fit into exact space in set.

Clarostat Ad-A-Switch line comprises the maximum utility with minimum stock investment. Series W (Wire Wound) obtainable from 50 to 50,000 ohms. Series C (new composition element) obtainable from 10,000 to 5,000,000 ohms. Both lines obtainable in all tapers—insulated shaft $1\frac{1}{2}$ " long. Wide use is indicated as follows: W-28 will service 128 sets; C-28 will service 108 sets; W-29, 77 sets; C-29, 66 sets; etc., etc.



**NEW CONTROL
REPLACEMENT GUIDE
ON REQUEST**

CLAROSTAT MFG. CO., INC.

287 North 6th Street, Brooklyn, N. Y.
AD-A-SWITCH was originated by Clarostat.

JUST OFF THE PRESS!
Free MAKE US YOUR
HEADQUARTERS FOR
1934 RADIO AND AMPLIFIER CATALOG
Deal DIRECT with Manufacturers
and SAVE BIG MONEY.
COAST TO COAST RADIO CORP.
121-K WEST 17th ST., NEW YORK, N. Y.

LATEST IN RADIO

(Continued from page 396)

will do this himself by word of mouth, but simply to hand his customers a circular at the time of delivering a repaired radio set. Such conversation as the Service Man may have, may be in the nature of what one person or another thinks of his installation. It must be remembered that all people are interested in health, beauty, the welfare of their children, vitality, etc.—all those things that go to make for fullest enjoyment and appreciation in life.

In addition to movable or semi-permanent installations, permanent ultra-violet lamp installations are becoming more and more popular. Among places selected for such installations are: the living room, bedroom, nursery, den, bathroom, kitchen, laundry, playroom, etc. Any radio Service Man is able to make a permanent installation in a very short time. The ingenious Service Man will discover an endless number of types of installation and places for installation, depending upon the layout of the home or rooms.

The sockets on most bridge and table lamps, as well as the sockets which form a part of most extension cords are made with a standard screw thread to support the lamp shade. The reflector will screw to this standard screw thread on the socket. The lamp will fit in regular lamp sockets. The transformer must be plugged into the house line 110-120 volts, 60 cycles, as the actual lamp operates on less than this voltage. The plug of the lamp or extension cord is then plugged into the top of the transformer.



Three essentials—
A—porcelain
cement (No. 385)
B—retouching kit
(No. 386)
C—waterproof
cement (No. 387)

for holding small parts in place, doing away with the usual nuts, screws and metal solder, and for filling holes and cracks as a sealing compound. The dipping cement is employed for coating electrical resistors and radio coil forms, as well as for general adhesive purposes.

Setting in a short time without the application of heat, liquid porcelain is proof against oil, acids, gases and heat up to 2,000 deg. F. It can be made waterproof. It is an excellent electrical insulator.

The box shown at B contains a complete radio cabinet retouching kit. It contains filler for cracks, a finishing block for smoothing and a touch-up fluid to retouch the "spots." This kit is a useful addition to the Service Man's kit.

The cement shown at C is strong, flexible, very fast drying, waterproof, and is especially adapted for repairing dynamic speaker cones which are torn, rattle or are loose from the spider. It can also be used for cementing grid caps and loose bases on tubes, etc.

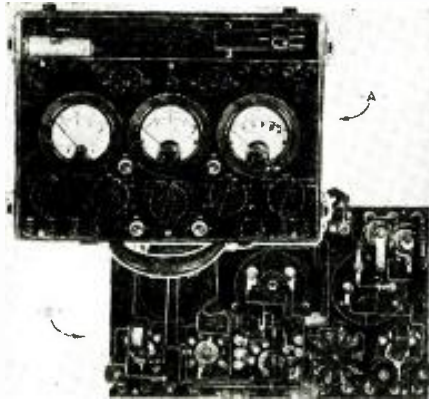

The appearance of the re-vamped analyzer
(No. 384)

BLUEPRINTS FOR REWIRING

The tester shown is a rewired Weston 547 Set Analyzer. All meters, multipliers and slunts are used. A circuit diagram has been designed using the three meters and all parts mentioned. The only additional new parts are the panel, cable and plug, rectifier, switches and necessary multipliers to increase the meter ranges.

The analyzer, when complete, tests A.C. and D.C. voltages, direct current, and three ranges of resistance, output and capacity. Point-to-point testing by use of either resistance or potential is conveniently arranged. All 4-, 5-, 6- and 7-prong large and small base tubes can be tested.

The circuit is also applicable to the Jewell 408 and 409. If one is willing to discard one meter; and to the Weston 545, as well as the 400 series of Supreme testers, if the oscillator and tube checker features are discarded.

The blueprints and instructions are available to the dealer and Service Man desiring to make these changes.

SERVICE AIDS

The practical "liquid porcelain cement" shown at A is available in three consistencies: a cement paste for application with trowel or similar tool; a dipping cement suitable for dipping, spraying or brushing; and a dry powder ready to be mixed with water to the desired consistency. The cement paste is widely employed in radio production assembly

P.A. SYSTEM AND 70 W. POWER STAGE

(Continued from page 394)

Six important features distinguish this recently announced P.A. system.

Taking up these features one by one, the amplifier weighs only 23 lbs., completely equipped and ready to use. It is extremely small in size, measuring $13\frac{1}{2}$ x $13\frac{1}{2}$ x $8\frac{1}{2}$ ins. deep. Hence, it can be carried about readily without strain, and because of its compactness it can be stowed out of the way during transit.

Ample power is certain, due to the fact that the amplifier consists of two well-designed A.F. stages employing a type 24 tube in the input stage and two type 45 tubes in push-pull in the output stage. The rectifier is a full-wave 80-type tube. A power output of 4.5 W. is attained; the gain is 79 db. Through unique circuit design, the usual push-pull input transformer is eliminated, simplifying construction and also reducing the weight of the amplifier.

It is merely necessary to plug it into a 110-120 V., 60 cycle A.C. outlet, snap the switch and talk. This permits it to be used by salesmen, demonstrators, lecturers, teachers, political campaigners, etc. No technical knowledge is required to operate it.

The super output stage, the second unit illustrated, was recently placed on the market. It supplies sufficient power to cover the largest airport or stadium. In this amplifier, a pair of type 845 transmitting tubes arranged in class A prime push-pull deliver 70 W. of undistorted power. (This is sufficient to carry up to 50 large dynamic speakers or units.)

In addition to the class A prime output stage, this amplifier includes a high-voltage rectifier, filter and power supply. Two half-wave type 866 rectifier tubes are arranged to give full-wave rectification. It is designed for use with any standard amplifier. An output of 28 V. at 500 ohms is required from the intermediate amplification stage in order to obtain the maximum output from the type 845 tubes.

The output stage may be used with any 110-125 V., 50 to 60 cycle A.C. power supply source. Its power consumption is 320 W. It has a gain level of 18.5 db. at 1000 cycles. The audible frequency response curve of

the amplifier covers the entire useful spectrum. The frequency response curve of this amplifier is unusually flat, and shows a deviation of less than 2 db. from 30 to 10,000 cycles. The hum level, in db. below maximum output, is 17 db.

former is used in this model, having an input impedance of 500 ohms and output impedances of 9, 15 and 500 ohms. These latter are obtained through the use of two output windings, a 15 ohm winding tapped at 9 ohms and a 500 ohm winding.

The mechanical construction is extremely rugged. There are three front panels. The top one is the output panel. An elbow shelf attached to this panel contains the two sockets for the type 845 tubes. There are four phone jacks on this panel; two for taking plate current readings on the 845's and two for testing grid current. The center panel contains pilot light indicators and the control switches, including the main power switch, the filament current switch and the high voltage switch. The two sockets for the type 866 tubes mount on a shelf attached to the lower panel. All three panels are of heavy steel with a baked "telephone" black enamel finish. Dust covers are furnished for the sides and back. The entire unit is self-supporting, but the design is such that it fits into a standard repeater rack. The use of elbow shelves for mounting the four sockets, makes the tubes readily accessible.

FIRE-SCREEN SPEAKER

(Continued from page 395)

the accompanying schematic diagram. It can be seen that this contains two rectifier tubes with the necessary chokes, condensers and resistors, to form a self-contained and complete unit.

A plug serves to connect the speaker to the regular radio receiver and a separate power switch applies the current to the speaker field when desired.

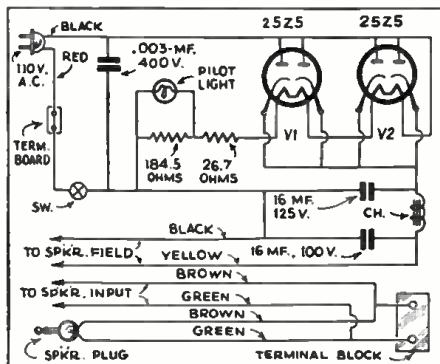

The circuit of the fire-screen speaker supply unit. The two tubes and filter, supply field current.

SHOP HOT-PLATE

The heating plate illustrated here makes it possible to rebuild radio filter blocks quicker and more efficiently than ever before.

Simply remove the metal-covered end of the filter block and place on the hot plate. Lay the block on one of its sides and after a few minutes turn the filter block on the next side until all four sides and the back have been heated. Should the pitch not run freely repeat the operation.



The electric hot-plate for use in melting the compound in filter condenser blocks and transformers (No. 388)

THE NX Universal Rectox Instrument

MEASURES

Current — Voltage — Resistance

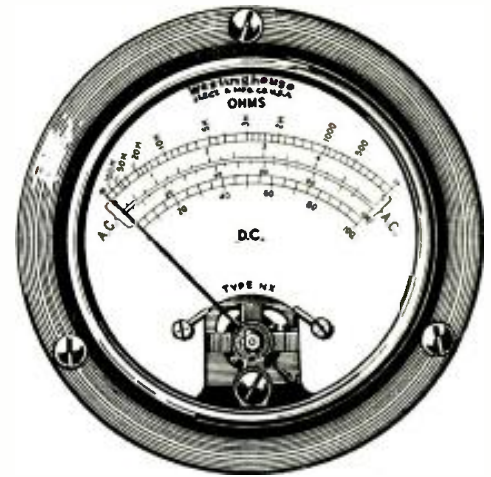

THIS Westinghouse instrument was specially developed for the radio service man, the home experimenter and the amateur.

For panel mounting, this self-contained instrument covers the following ranges:

Milliamps., d-c.	0-1
Milliamps., a-c.	0-1
Millivolts, d-c.	0-100
Volts, a-c.	0-5

To give additional ranges, we can supply resistances for voltage measurements, combination shunts for current measurements, and resistors for resistance measurements. With these accessories the following ranges can be obtained:

Volts, d-c.	0-1-5-10-50-100-200-500-1000
Volts, a-c.	0-10-50-100-200-500-1000

Westinghouse



Since 1888, manufacturers of highest quality instruments, which are now available at standard prices. There is no longer any reason for accepting lower standards.

Territory is still open for dealers.

Milliamps., d-c.	0-5-10-50-100-500
Milliamps., a-c.	0-5-10-50-100
Amperes, d-c.	0-1-5-10-50
Ohms	0-1000-10,000-100,000

With these ranges, practically any measurement of voltage, current or resistance can be made for checking receiving-set operation; for test bench work; for laboratory experiments; or for the adjustment and operation of transmitting sets. The instrument with its complete set of accessories mounted on a panel or in a box, with the necessary switches, makes an ideal test set.

Catalog 43-341 describes the construction features that result in the high quality of the NX Universal Rectox Instrument, lists the instrument and all accessories, and includes connection diagrams. Send the coupon or a post card for your copy.

SEND FOR CATALOG

Westinghouse Electric & Manufacturing Co.
Dept. 113, Room 2-N—East Pittsburgh, Pa.

Please send free copy of Catalog 43-341 containing complete description of the Universal Rectox Instrument.

Name

Address..... T 79809

City.....State..... RC 1-34

TURN TO PAGE 390

YOU have no doubt noticed the new section that is appearing in RADIO-CRAFT, called the Radio Month in Review. In this new section, important developments throughout the entire industry of radio are analyzed and reviewed in a concise form that includes only the "grain"—the "chaff" is discarded.

How do you like this new section? Do you find it interesting? We will appreciate your comments!

Dependable Sensational Performance!

.. BUD LOUD SPEAKERS

NORMAL efficiency 24 to 25 watts
—peak capacity 50 watts! BUD'S ton diaphragm and voice coil assembly assure higher efficiency and far greater dependability. Write for literature on BUD units, all aluminum, weatherproof "NATURAL-TONE" trumpets, microphones, excellers, air column horns.

Get details of Five-Day Free Trial and information on our new high frequency theatre unit.

BUD SPEAKER CO.
1111 JACKSON AVENUE
TOLEDO, OHIO—U.S.A.

ELECTRICAL BOOKS
shipped
FREE

10
BIG BOOKS

A-C-RADIO TELEVISION
Every Electrical Subject Covered

Here's great news for anybody interested in Electricity. BRAND NEW 1933 edition of Applied Electricity brought right down to date with every NEW electrical subject fully covered. 10 big Volumes and all shipped FREE for examination.

BIG FIELD! Big Demand Big Pay! Men who understand electricity are urgently needed right now in thousands of Industries. Autos, airplanes, machine shops—practically every industry depends on electricity and men who know this subject make big money. Pleasant, fascinating work, easy to learn and do; learn quickly with these books. Send coupon for a set for FREE examination and see for yourself.

FREE { A year's consulting membership in the American Technical Society now given free to all readers of this famous "Cyclopedia of Electricity. Many say, "That's worth more than cost of books." }

AMERICAN TECHNICAL SOCIETY
Dept. E126, Drexel at 58th St., Chicago

AMERICAN TECHNICAL SOCIETY,
Dept. E126, Drexel at 58th St., Chicago

Send for 10 days' free use. BRAND NEW 10 volume set of Electrical Engineering. In return for mailing this coupon promptly, send absolutely free certificate of membership in the American Technical Society entitling me to free consulting privilege for one year. I will pay the few cents delivery charges on the books. If I wish I may return them in 10 days and owe you nothing, but if I keep them I will send \$2.00 after 10 days, then \$2.00 a month until the special sale price of only \$29.80 is paid.

Name
Address State
City
Employed by
Address

It satisfies Capt. Hall!

A Short Wave Receiver that satisfies the critical CAPT. HORACE I. HALL, has to be good. The Captain now uses the POSTAL INTERNATIONAL SUPERHETERODYNE for his DX hunting. Received stations in every continent within 24 hours on the POSTAL INTERNATIONAL.

New Short Wave Sensation
For the Amateur or Short-Wave Fan. Professional-Custom built. EMPLOYING TUNED R.F. PRESELECTOR. New triple driver coil—Instantaneous band spread. C.W. beat oscillator—Electron-coupled oscillator—Phon act—3 watt output—Antenna trimmer. No image, harmonics or drift.

A new, low price for Professional receivers. Sold direct from our laboratory with money-back guarantee.

Short-Wave Fans and Amateurs, you owe it to yourself to send for our FREE Circular describing and illustrating the POSTAL INTERNATIONAL and also our special price offer to Radio-Craft Readers.

POSTAL RADIO
135 N. Liberty St.
New York, N. Y.

UNIVERSAL BATTERY CONVERTERS

Maximum efficiency for amplifier and public address work or most any device requiring 110 A.C. (except radio receivers). Send for descriptive Circular. 60 watt-battery drain 6v. at 15 amps. List \$36.00. 150 watt-battery drain 12v. at 18 amps. List \$60.00 (Standard Discounts).

UNIVERSAL MICROPHONE CO., LTD.,
424 Warren Lane,
Inglewood, Calif., U.S.A.

Transformers REWOUND AND REBUILT

Pemberton's 17 year record in manufacturing, rewinding and rebuilding transformers assures performance in many cases, even far superior than the original. Each completed job is an achievement of perfection in workmanship, materials and electrical characteristics. Our specialists are trained to repair transformers within 12 hours. Write for interesting brochure, "Transformers" and Transformer Rebuilding Service. Address Dept. RC

PEMBERTON LABORATORIES
921 Parkview Avenue Fort Wayne, Indiana

WRITE FOR NEW CATALOG

A RADIO SCHOOL'S 20th BIRTHDAY

(Continued from page 401)

and mental equipment must be analyzed and directed toward the branch of radio in which they will be most likely to do well. Such an analysis must be made not merely before a course has been written, but must be a continuous process throughout the life of the radio school.

The teaching methods employed must keep pace with both the changes in industry and changes in student requirements. Continual development is the law of leadership. Abstractions and pure theory have little value in a radio course which must be written from the practical viewpoint. It must be concrete and specific, rather than vague and theoretical. It must illustrate from experience, and set forth practices and techniques which can be grasped by men attracted to such a course by personal and highly practical reasons, first among which is certainly the desire to earn a living.

Many radio schools have sprung into existence and continued with varying degrees of success for longer or shorter periods. Any which have weathered the changes in the radio and economic worlds in recent years have undoubtedly discovered and followed the principles set forth in this article. One of these schools—and it is not the purpose of this article to claim that it is the only school—offers a very interesting example of cooperation among a group of conscientious, capable radio instructors, their students and graduates, and the industry they all serve.

Twenty Years Ago

Twenty years ago, in 1914 to be exact, an instructor in Applied Electricity and Steam Engineering at the McKinley Technical High School in Washington, D. C., was besieged by his students with demands for information on the *why* and *how* of "wireless." Wireless communication fired the imagination of so many young men that James E. Smith, who was this instructor, realized the short course in wireless given as part of the high school course, was not enough. The demands of outsiders who wanted radio operators' training encouraged him to establish a small local school for would-be "brass pounders."

The interest shown was so great that to the surprise of Mr. Smith as much as of any one else, the school had to be enlarged and the course extended. Still the demand grew. A second school was opened in Baltimore because of the demands from the Baltimore area and its importance as a shipping center. As interest in wireless and its possibilities swept the country, the cry arose from many not so fortunate as to be able to come to Washington or Baltimore for their training.

The only alternative was to take the training to those who wanted it, and Mr. Smith met the situation when he pioneered the first home-study wireless course, maintaining his residence school in Washington for local men and training all others by correspondence with the cooperation of Uncle Sam's mailmen.

Wireless had never before been taught by mail. Class-room methods of presentation would not work. Without the advantages of student questions and a blackboard, it became necessary to evolve a method which would not require such aids. Some of the problems involved in helping men to understand when they were not within earshot, were most perplexing. It took patient study of the make-up of these men, their background, energy, education, and native intelligence, to make it possible to develop a method of training by mail which would compare with residence school methods.

The Advent of Broadcasting

In 1920, there came a revolution in the field of wireless. Modern broadcasting had its humble beginning and the public began to think and talk about "radio" (a colloquial reference to *voice* and *music* transmission by radio—*Technical Editor*). Since broadcasting was based upon wireless (code) telegraphy, it was still essential for the man wishing training to know "wireless." On top of this came the urgent demand from every direction for instruction on building broadcast receivers—receivers which would bring in distant as well as local stations.

These were the days of the crystal detector and the one-tube regenerative receiver. Broadcasting was assuming approximately 50 per cent of the importance of the entire field, so the training was modified to fit the growing needs. Some people questioned why a radio school should teach basic radio theory, tuned circuits, principles of vacuum tubes, antennas, transmitters, transformers, rectifiers, and failed to see how all this applied to practical set building. Even though there were cases where it was as difficult to persuade the student of the importance of these subjects as it was to teach him, every essential feature was maintained as an integral part of the course and was compulsory for graduation.

Men who had the ambition to study not only what they *thought* important, but what their instructor—already a veteran in the game—*knew* they needed, are today among the leaders in the radio industry. They mastered enough fundamental, basic theory so that their development came with the least amount of effort. Basic training is, today, as it was then, more important than any other type of instruction.

Many readers will recall those first hectic years of radio when all kinds of make-shift apparatus had to do. Transmitting engineers were satisfied if they got almost any kind of



Above is a set-up of apparatus for studying the principle of generation and detection, made by the student of radio. The three units are assembled from the parts shown below.



(At the left is a complete layout of the apparatus supplied to the student, when he starts his course in radio. The layout above, made from the parts shown on the left is used to illustrate the principles of detection and amplification. Many demonstration layouts are assembled throughout the duration of the course. By actually trying the experiments as they are explained the students get a dependable base upon which to build their knowledge of radio.



radio waves into space. Listeners were satisfied with any kind of receiver which would bring magic sounds out of the air, little as those sounds might resemble the human voice or real music.

As radio got over its early growing pains and the demand for good transmission, better receivers, better tubes and circuits made itself felt, the screwdriver, hammer, and soldering-iron radioman lost ground. Trained men with an adequate background in radio stepped out in front and the ruthless elimination of the unqualified made many a radioman thankful for his sound, basic training and correct methods of instruction.

The "Boom Days" of Radio

From 1920 to 1930, radio steadily threw off the shackles of inferior equipment and facilities. Both transmission and reception had developed methods which appeared, to all but far-sighted engineers, to be the acme of perfection. Invention and science are powerful aids to progress when able men are building an industry; and about 1930 another revolution took place in radio. Without losing any of the valuable ground gained, the industry suddenly expanded with almost explosive force into a hundred related fields, each with its opportunities and problems to challenge the trained radioman to new successes.

Everyone realizes, in some degree, what has happened and many a qualified man has profited by radio's vigorous expansion into talking pictures, P. A. systems, light control devices, television, aircraft radio, police radio, short-wave radio, beam transmission, point-to-point communication, and many other fields.

No school which hoped to train leaders for the new industries dared overlook such far-reaching changes. Mr. Smith, now a veteran of two revolutions, had already incorporated in his course many of the new developments. Long before his student body realized the need, he recognized the necessity of modifying the old "how to do it" and "why it works" method even though it had stood the test of time. A whole series of specialized courses was developed, corresponding roughly with the directions of the expansion in the industry, and including special training in receiver servicing and merchandising, P. A. systems, talking pictures, aircraft radio, broadcast, marine and point-to-point radio telegraphy, and television. Even though television is, even at this writing, still in its infancy, there were enough men interested in it, much earlier, from the experimental standpoint and with the desire to be prepared for developments, so that their pioneering spirit appealed to the pioneering spirit of this school.

In immediate conjunction with these novel and highly specialized courses, another step was taken which required even more courage and hindsight rather than foresight. With the need for specialization, there was the temptation to overlook the more fundamental, the controlling need for absolutely basic training. To fulfill this need, there was created a fundamental training which included home laboratory work and which every student, except the most experienced and highly qualified, was required to master before advancing to his chosen specialty. Even when the wisdom of this policy was questioned by ambitious and sometimes impatient students, it was insisted upon—to be thankfully acknowledged afterwards. Every student has to discover for himself that the stronger and deeper his foundation, the bigger the building he can raise upon it.

The expansion of radio into allied fields and applications in other industries quickly absorbed many good men from the parent industry. Once the important positions were filled, new men desiring to enter had to undergo apprenticeship or its equivalent in training. As it became clear that the best positions had to be earned by the individual's own growth in the industry, it also became evident that a more definite division was being made between the servicing and maintenance of various types of home equipment on the one hand, and the various forms of communication on the other hand. Newcomers to the industry were drawn toward one side or the other, but once the major choice was made, they were faced with the very difficult problem of equipping themselves not for one limited branch of the division, but for, (a) a whole group of possible opportunities and ac-

CIRCUITS MAY CHANGE



Model 663 Volt-Ohmmeter



Model 664 Capacity Meter



Model 665 Analyser

But

THESE INSTRUMENTS DO NOT BECOME OBSOLETE

These Weston Radio Instruments are measurers of fundamental quantities. They have no circuit limitations which cause early obsolescence.

The Model 663 measures in ohms and provides for the measurement of all values of resistance as well as all values of DC current and voltage encountered in radio servicing.

The Model 664 measures in microfarads and provides for the measurement of capacity values, AC voltages and output readings.

The Model 665 measures primarily volts and milliamperes and makes all necessary voltage, current and resistance readings in any kind of a radio receiver.

Designed and built to high Weston standards, these instruments represent a life-time investment. Each can be mounted in an individual case, or with others of the Weston Standardized Service Units in a combination case. The coupon will bring you complete information. Weston Electrical Instrument Corporation, 599 Frelinghuysen Avenue, Newark, N. J.



WESTON
Radio Instruments

WESTON ELECTRICAL INSTRUMENT CORPORATION
599 Frelinghuysen Ave., Newark, N. J.

Send Bulletin RA Name.....
on Weston Radio Address.....
Instruments.

5 Service Tools in One!



IRC

- 1 DUAL RESISTANCE INDICATOR.
- 2 CALIBRATED RHEOSTAT OR VARIABLE RESISTOR.
- 3 CALIBRATED POTENTIOMETER OR VOLTAGE DIVIDER.
- 4 MEASURING RESISTANCES BY SUBSTITUTION METHOD.
- 5 TEMPORARY STANDARD RESISTOR.

The NEW IRC Dual Resistance Indicator—the handiest tool for radio service, lab or amateur use. Quickly tells the correct value for ANY resistor. Has many other uses besides. So moderately priced you can't afford to be without one.

TWO SCALES permit accurate readings from 100 to 10,000 ohms and 10,000 to 100,000 ohms. IMPROVED BALL BEARING CONTACT prevents damage to wires. Resistance rods are wound with heavy wire and enclosed in sturdy metal case. Slider is PERMANENTLY ATTACHED, insuring quick, easy adjustment and leaving user's hands free. Indicator range may be extended indefinitely by adding fixed resistors. Built to last for years. Complete, easy instructions included.

You'll use it more than any other tool in your kit. Order yours today!

\$2.70

Net to trade (\$4.50 list)

When ordering by mail include 15c postage and name your IRC jobber.

Where 5% accuracy is satisfactory, may also be used in place of expensive resistor standards and decade boxes. Descriptive folder free on request.

INTERNATIONAL RESISTANCE CO.
2100 ARCH STREET PHILADELPHIA, PA.
In Canada, 74 Wellington Street W., Toronto, Ont.
A NEW PRODUCT BY THE MAKERS OF FAMOUS IRC RESISTORS

Make MORE MONEY in RADIO with R.T.A. Professional TRAINING

Home study with R.T.A.—plus lifetime membership in our large, powerful association of radio service men—brings you up to date in all improvements in radio, television, sound engineering, and more, you among the real money-makers in this expanding field. Unless you have this high-type professional training you will find it hard to get out of the poorly paid "tinkerer" class.



New-Type Set Analyzer Included

As part of R.T.A. training you get this up-to-the-minute Set Analyzer and Trouble Shooter. After a few easy lessons you are ready to use it for immediate money-making, competing with "adjusters" without fear. With this wonderful piece of equipment, backed by R.T.A. professional training, you need have no fear or worry over the future. Even though there should never be a new radio set constructed—or not—your improvement in radio made—there are enough sets now in service that need constant attention to assure you good money as an accepted Radio-technician.

Start Money-Making Quickly

R.T.A. Training is especially designed—and given you by one of the outstanding teachers of radio technology in the world—to get you into the profitable end of radio quickly. It is not empty theory, but practical, down-to-earth work that makes you a money-maker in this immense field in the shortest possible time. Don't delay your start toward success. Write at once for all details about R.T.A. training. The Coupon below lists FACTS—outstanding ones that may open up a new, depression-proof future for you.

MAIL COUPON NOW!

RADIO TRAINING ASS'N. OF AMERICA.

4513 Ravenswood Av., Dept. RC-1, Chicago, Ill.

Send me all the FACTS about R.T.A. professional training together with information about the opportunities existing for R.T.A. Radiotechnicians today.

NAME.....

ADDRESS.....

Try this FORMULA

WHEN you design or build that new Set Analyzer, Decade Box, Bridge, Ohmmeter or High Resistance Voltmeter why not try this FORMULA:
Q+A+MD = PwWR

LC
When Q equals QUALITY and A equals ACCURACY MD equals MODERN DESIGN and LC equals LOW COST and LAST COST then PwWR is always PRECISION WIRE WOUND RESISTORS.
RESISTANCE RANGE: .25 Ohm to 1 Megohm

TYPE "F"

Normal Rating 1 Watt
Maximum Length 1"
Maximum Diameter 1/4"
Length of Leads 1 1/4"
Furnished with No. 18 Tinned Copper Leads.



TYPE "D"

Normal Rating 1/2 Watt
Maximum Length 3/4"
Maximum Diameter 1/8"
Length of Leads 1 1/4"
Furnished with No. 18 Tinned Copper Leads.

Free Booklets and Price List

Free Custom Built Wire Wound Resistors, Mfg. by

PRECISION RESISTOR CO.
334 Badger Ave. Newark, N. J.

TRUMAN RADIOS

are

CUSTOM BUILT
Broadcast, Shortwave and
Auto Radios

Write for dealers prices

TRUMAN RADIO SHOP
7443 Stewart Ave., Chicago, Ill.

activities connected with servicing and maintenance; or with the communications, as the case happened to be.

Enter—the Trained Service Man

The Service Man of tomorrow—which means the Service Man who is being trained today—must know a great deal more than standard servicing practice. In addition to basic servicing training, techniques available, and a reasonable insight into radio merchandising, buying, selling, and record keeping, he must understand electronic devices. Public address systems call for a specialized, although related kind of servicing knowledge. The undeniable progress made by television in the past three years means that the fully qualified Service Man must have a good insight into all angles of this development.

Any training to prepare a man for a field like this must be highly specialized with respect to servicing and maintenance. At the same time, it must be generalized to include all these and other related servicing fields. The educational staff of a radio institute, in its endeavors to train the Service Man of tomorrow, must revise and realign its training to fit the major trend outlined above.

The needs of the radio man attracted toward some branches of the communications field are changing—have changed—as radically as those of the man in the servicing end of radio, and a similar realignment of the training for these men has been accomplished. First, of course, the student of such a course must be sure he will receive all Governmental license qualifications, and this phase of the training includes basic theory of transmitting, practical transmitters, traffic handling, laws and regulations. The radio code and suitable code training apparatus are included. A training which stops here, ignores the new directions and expansions of radio communications, however. The educational staff of the school with which the writer is associated has met the situation by including, in addition to the study of advanced phases of transformer, dynamo-electric machinery, storage batteries, and power supply systems, much information of a highly practical nature on point-to-point operation, marine and police radio. Many interesting developments lie ahead in the aircraft field and a complete, detailed study of radio in its applications to aircraft which must be a part of any course in communications, is included also.

Radio Training in 1934

The 1934 course of instruction must prepare a man to go into one or the other of these branches of radio at the most convenient point, work up rapidly from the bottom and move forward in the same or some related branch to the higher position which will alone satisfy his ambition. Instruction which leads to this cannot stop with mere technical training. Instructors should aim to help the student become a man among men. They must encourage him to develop a business-like attitude; show him how to fit into an organization; and if owning or operating his own business is his ultimate goal, help him to avoid the pitfalls which wait for the inexperienced. Lectures on self-adjustment form a part of the course.

As a matter of fact, non-technical problems comprise a large percentage of those which an ambitious student must meet and overcome. The head of any school worthy of the name must give his personal attention to such problems. Mr. Smith does this personally. A small corps of highly trained assistants devote their entire time to all the non-technical matters which may affect a student's progress.

Many seem to have the idea that good, sound training in a profitable field is available only to men who have financial backing. Experienced observers point out that the most successful graduates of a course like the one described in this article are the ones who have had the fewest advantages to begin with, some having had to literally earn their way through. This idea has been developed by the special staff referred to above so that the beginner with ambition and courage can earn enough to pay for his training if he will apply himself. Direct instruction is given in making spare-time money through methods which have been used successfully by other students.

Creation of adequate and successful radio training is not an insignificant matter. Years of experience years of work, must go into it. It is no one-man job, and the staff must be composed of men who have been through the mill themselves, men who can face problems and who have the happy faculty of finding the solution for others. Unceasing alertness toward new trends and developments is the price of being up-to-date. Every possible bit of information bearing on any branch of radio must be secured, read, studied, weighed, thought through to its effects, and then—but not until then—introduced into the proper place in the course. Such information must dovetail into what has gone before and into what comes after and must be interestingly, lucidly stated.

A school to do this must maintain a really complete library of facts, not only the facts which appear in books and magazines, but on every item published in connection with every phase of the subject. This information must be collected, classified, cross-referenced and filed for current and future use by the members of the staff.

To sum up, education in a field which everywhere borders on engineering must itself be engineered. By "engineering a course of training" is meant developing and maintaining a course which with reasonable economies of time, money, and material will yet turn out the finest possible product; the kind of radioman most likely to be useful to the industry and, therefore, most likely to make a personal success of himself.

SHORT-CUTS

(Continued from page 402)

The circuit of this receiver employs a type 22 screen-grid tube in the R.F. stage, followed by a type 27 detector, with two stages of A.F. amplification. A 24 tube, when used instead of the 22 gives slightly better performance with decreased hum. Figure 5 shows the hookup of the first two tubes, together with the changes. (The Polydyne set used the same circuit.)

Remove the bolts which fasten coils L1 and L2 to the chassis and separate them to a distance of 2 1/2 in. between centers, bolting each one securely to the chassis. Next, wind 20 turns of No. 28 enameled wire over the secondary of the antenna coupler. Connect this to the antenna and ground in place of the original primary, which is not used. It may be necessary to loosen the rotor of the condenser which tunes the input of the R.F. tube, and slip it out of mesh a trifle, in order to obtain a better response on the higher frequencies. Readjust the regulating screw of the regeneration condenser to obtain slight regeneration at 600 kc., with the volume control at maximum. Where an antenna of 125 ft. or longer is used, a 500 mmf. fixed condenser in series with the antenna post helps to sharpen the tuning.

Besides improving selectivity, this arrangement adds a lot of pep on the lower frequencies, where it is needed most.

Transformer Repairs

When the secondary winding of a transformer "shorted" and it was impossible to purchase the correct size, we repaired the wire by removing the wire, unkinking and stretching it, applying a coat of shellac, covering the shellaced wire with a 1 in. spiral of paper crepe and then applying a coat of shellac on the paper-covered wire (Fig. 6).

H. LUPPERT.

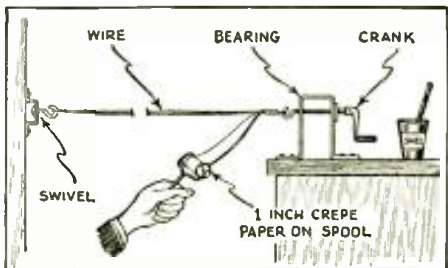

Fig. 6
An easy way to cover wire.

RADIO for 1934

NO SERVICEMAN DEALER
OR SET BUILDER CAN AFFORD
TO BE WITHOUT THIS BOOK

Send for the most valuable book in Radio. Packed with quality and value. Lists the most complete line of radio replacement parts for any service requirement. Features latest type set-building kits, test instruments, Long and Short Wave Radios, Sound Systems, etc. Write for this FREE Catalog today!



FREE

ALLIED RADIO CORP.,

Dept. D, 833 W. Jackson Blvd.
Chicago, Illinois.
Please send me FREE your New 1934 Radio Book.

Name _____
Address _____
City _____ State _____

Allied Radio

STEWART-WARNER FACTORY CO-OPERATION FOR SERVICE MEN

Service meetings will be held all over the country by special factory radio field engineers. Complete diagram talk on new as well as old Stewart-Warner circuits will show you the easy way to service Stewart Warner radio sets. Service manuals on all new Home and Auto Sets will be given free.

For time and place of meeting, write

Service Department

STEWART-WARNER CORP.

1826 Diversey Parkway - - Chicago

SERVICEMEN!

THE MOST COMPLETE LINE OF CONDENSERS
AND RESISTORS FOR EVERY RADIO USE
Write for our new 10-page Catalog folder free of charge



76 Washington Street

Brooklyn, N. Y.

JUST OFF THE PRESS!

Free MAKE US YOUR HEADQUARTERS FOR PUBLIC ADDRESS AMPLIFIERS and SAVE BIG MONEY.

1934 RADIO-AMPLIFIER CATALOG

COAST TO COAST RADIO CORP.
151-N WEST 57th ST., NEW YORK, N. Y.

Be sure to turn to page 438 of this issue and get full particulars about the NEW 1933 OFFICIAL AUTO-RADIO SERVICE MANUAL which is now published.

analyzer panel. The extra element is wired into the analyzer as G and has its own current position and button, besides 3 voltage measurement positions, namely: G-II, G-K, and G-P.

The top cap on all tubes (except a few special tubes) is the control grid, marked CG on the analyzer. This circuit ends at a tip-jack on the panel and at a metal cap on the side of the cable plug. CG current can be read from the CG position by pressing the CG button. Voltage measurements are from CG to H, CG to K, and CG to P.

By means of a small copper-oxide rectifier, A.C. measurements may be made. The main thing to remember when taking A.C. voltage readings is, that the readings are approximately 80 per cent of the true reading on voltages above 100, and 70 per cent or a little less on voltages below 100.

TABLE I

Tube Type	Plate Volts	Plate Ma.	Open Grid.
2 A 3 PP	300	40	120
2 A 5	250	34	80
2 A 7	250	4	13
2 B 7	250	6	17
6 A 7	100	2	9
6 B 7	100	5.5	15
6 P 7 Triode	100	3.5	12
2 A 6 Triode	250	1	5
6 A 4	165	20	60
22	135	2	5
24 A	180	4	8
26	90	4	10
27	180	6	17
30	90	2.5	7
31	135	8	30
32	135	1.5	4
33	135	1.5	30
34	180	3	5
35	250	6	10
36	135	3	7
37	135	4	15
38	100	7	27
41	125	11	40
42	250	34	100
43	95	20	80
39-44	90	5	15
45	250	32	75
46 Class "A"	250	22	90
46 Class "B"	400 (1)	6	6
47	250	32	84
48	95	4.5	100
49 Class "A"	135	5	25
49 Class "B"	180	2	2
50	450	5.5	120
53 Class "A"	250	6	40
53 Class "B"	250	14	14
55 Triode	250	8	20
56	250	5	23
57	250	2	7.5
58	250	8	15
59 Pentode	250	35	90
71-A	180	20	90
75 Triode	100	.5	1
77	100	1.8	4
78	100	5.5	10
79 Class "B"	180	7.5	7.5
85 Triode	100	3	12
89 Pentode	100	11	40
99	90	2.5	9
12-A	90	5	13
20	90	3	9
01-A	90	3	7
10	425	30	60

(1) No signal.

The above tabulation of plate current values may vary in actual practice, due to circuit structure and circuit constants.

Construction

Building and wiring any analyzer is distinctly not a job to be tackled by a novice.

The accuracy of the finished instrument depends entirely on the tolerances of the parts used. Since precision multipliers and shunts are rather expensive, a little judicious substitution may save the builder a few dollars. The rotary switches and push-button switches can be made by the builder.

The panel is made in two parts, an inner and an outer panel. The inner panel holds the sockets, and all mounting screws, etc., while the outer panel is neatly engraved and gives the unit a professional appearance. This also permits changes in the parts and in their mounting arrangement, without showing any unsightly, unused screw holes, etc. (since the outer panel hides them).

List of Parts

- One Weston milliammeter, model 301, 27 or 50 millivolts, 0-1 ma. range;
- Two Jewell 2-deck, 24-point switches, Sw.1 and Sw.2;
- Two Jewell small bar handles;
- One 4-deck, 3-point switch, Sw.3;
- Six push-button switches, Sw.5, Sw.6, Sw.7, Sw.8, Sw.9, Sw.10;
- Eight meter shunts 2.5-5-10-25-50-100-250-500 ma., R1 to R8;
- Eight voltage multipliers, 4,950-5,000-15,000-25,000-50,000 ohms and .15-meg.-.25-meg.-.5-meg., R9 to R16;
- One D.P.D.T. switch, Sw.4;
- Four sockets 4-5-6-7 comb.;
- Six tip-jacks;
- One engraved panel, 7 x 13 x 3/16-ins.;
- One bakelite panel, 7 x 13 x 1/4-in.;
- One Taurex rectifier with scale-adjusting resistor, Rect.;
- One 1000 ohm rheostat, R22;
- One Na-Aid analyzer cable with 4 adaptors, type 907 WICA;
- Five resistors for ohmmeter, 50, 150, 3,600, 4,000 and 36,000 ohms, R17 to R21;
- Three rolls of hookup wire, colored red, green and black;
- One carrying case to fit completed analyzer chassis;
- One 4 1/2 V. battery, B1;
- One 40 1/2 V. special battery, 7 x 5 1/2 x 5/8-in., B2.

AUTO RADIO

(Continued from page 407)

partment of the car where it will be invisible.

Final Operations

One cable connection is made from the radio chassis to the motor-generator; one cable runs from the radio chassis to the remote control junction box and to the speaker; another cable makes connection from the remote control junction box to the speaker and remote control junction box to the ammeter or "A" battery connection. The condenser control cable is brought from the remote control on the steering rod back to the chassis and a connection is made to the condenser cable wheel as explained previously in the text. The tone control, also shown in Fig. 22, is mounted to the instrument board; connection is made with a cable to the speaker. When making the installation, be sure to securely fasten all the cables to the car—and especially, great care should be taken to make a good ground connection on all the junctions where the cables come together, and also to ground all the cable shields connecting one part to another. (Refer to Page 288 of the November, 1933 issue of RADIO-CRAFT for further details concerning noise elimination in auto radio installations.—*Assoc. Editor*)

The aerial installation is best made in the top of the car by placing a copper screen in the top and bringing a shielded cable down to the chassis where a connection is made by means of the plug. If you are not very well acquainted with aerial installations I advise you to check up on some of the informative literature available on such work. (For instance, the 64 page book, "Automobile Radio and Servicing," and preceding issues of RADIO-CRAFT.—*Technical Editor*)

If you adhere to all the specifications as given in this description when building and installing this radio set you surely will have an auto radio which will give you the best of results, considering selectivity, sensitivity, tone quality, distance, and trouble-free performance.

List of Parts

- One chassis No. 16 gauge sheet steel, part No. 1;
- One chassis box No. 16 gauge sheet steel, part No. 2;
- One chassis box cover No. 16 gauge sheet steel, part No. 4;
- One motor-generator box No. 16 gauge sheet steel, part No. 5;
- Four condenser brackets, part No. 6;

Two chassis brackets, part No. 7;
 One chassis box packing—soft rubber, part No. 8;
 Two motor-generator box packing strips, part No. 9;
 Two motor-generator box packing strips, part No. 10;
 One junction box packing, part No. 11;
 Seven tube cushion rings, part No. 12;
 Five rubber grommets for 5/16-in. hole, part No. 13;
 Two rubber grommets for 7/16-in. hole, part No. 14;
 Two resistor and condenser mounting brackets, part No. 15;
 One 7-prong socket, part No. 16;
 One 7-prong plug, part No. 17;
 One antenna coil with shield can, part No. 18;
 One R.F. coil with shield can, part No. 19;
 One composite I.F. oscillator unit, part No. 20;
 One I.F. coil unit, 175 kc., part No. 21;
 Four 5-prong sockets, parts Nos. 22 and 23;
 Three 6-prong sockets, parts Nos. 24 and 25;
 Seven tube shields, parts 26, 27 and 28;
 One push-pull input transformer, part No. 29;
 One 350 mmf. 3-gang variable condenser, $\frac{1}{2}$ x $\frac{3}{8}$ shaft, part No. 30;
 One .002 mf. mica condenser, part No. 31;
 One 250 mmf. mica condenser, part No. 32;
 Three .05 mf. tubular condensers, 200 V., part No. 33;
 One 500 mmf. tubular condenser, 600 V., part No. 34;
 Two double 0.1-mf. condensers, 200 V., part No. 35;
 One .02-mf. condenser, 200 V., part No. 36;
 One .5-mf. condenser, 200 V., part No. 37;
 One .5-mf. condenser, 200 V., part No. 38;
 One electrolytic condenser 10 mF., part No. 39;
 One .15-meg. resistor, part No. 40;
 Two 1 meg. resistors, 1/3-watt, part No. 41;
 One .5-meg. resistor, 1/3-watt, part No. 42;
 One .5-meg. resistor, 1/3-watt, part No. 43;
 One 500 ohm resistor, 1/3-watt, part No. 44;
 One .1-meg. resistor, 1/3-watt, part No. 45;
 One 2,000 ohm resistor, 1/3-watt, part No. 46;
 Two 10,000 ohm resistors, 1/3-watt, part No. 47;
 One 35,000 ohm resistors, 1/3-watt, part No. 48;
 One 30,000 ohm resistor, 1/3-watt, part No. 49;
 One 400 ohm resistor, 1/3-watt, part No. 50;
 One 600 ohm resistor, 1/3-watt, part No. 51;
 Six screen-grid connectors, part No. 52;
 One 6 or 8 in. speaker with 4 ohm field, part No. 53;
 Six or eight spark plug suppressors, parts No. 54;
 One distributor suppressor, part No. 55;
 One tone control knob, part No. 56;
 One motor-generator, part No. 57;
 One remote control unit, complete with junction box, part No. 58;
 Ten 8-32 flat-head screws, $\frac{3}{8}$ -in. long, part No. 59;
 Eight 8-32 round-head, self-tapping screws, $\frac{3}{4}$ -in. long, part No. 60;
 Eight $\frac{1}{4}$ thread, round-head screws, $1\frac{1}{4}$ in. long, complete with nuts and washers, for box mounting, part No. 61;
 As needed: 6-32 round-head screws, part No. 62;
 As needed: 6-32 nuts and lock washers, part No. 63;
 One tone control bracket for instrument board mounting, part No. 64;
 One shielded cable, 2 No. 16 gauge wire, approx. 3 ft. long (if motor-generator is mounted in rear), part No. 65;
 One shielded cable (remote control to radio set) 3 wires, No. 14 gauge, 8 ft. long, part No. 66;
 One shielded cable (ammeter to remote control junction box) No. 14 wire, 4 ft. long, part No. 67;
 One shielded cable (remote control junction box to speaker) 1-wire, No. 16 gauge, 4 ft. long, part No. 68;
 One shielded cable (radio set to speaker) 3 wires, 8 ft. long, part No. 70;
 One tone control cable, 2 wires, No. 18 gauge, 3 ft. long, part No. 71;
 One type 37 tube;
 Three type 39 tubes;
 One type 85 tube;
 Two type 89 tubes.



NATIONAL UNION MEANS MORE THAN RADIO TUBES

Service Men! Dealers! Act On These Points!

- EQUIPMENT.** Modern testing instruments, service manuals and shop equipment are given with National Union tube purchases. The wide awake dealer realizes that when he obtains his equipment in this way, he has both the guarantee of the manufacturer and the backing of National Union.
- PROFIT.** The ten cent higher list price of National Union tubes enables the service man to make the highest margin of profit on his tube sales.
- STANDARD PRICES.** National Union tubes are sold everywhere at full list price so the service man need not fear ill-will of customers who might otherwise see the tubes in "cut price" stores.
- QUALITY.** Strict adherence to closer manufacturing limits is responsible for the consistent superiority of National Union tubes. They are fully guaranteed. Continued customer satisfaction is assured.
- SERVICE AIDS.** For more than three years National Union has specialized in service aids. These valuable aids available at no cost cannot be duplicated from any other single source. Every National Union service outlet can testify to what this has meant to him in better service work and more profit.

FREE! Although subject to withdrawal without notice, the items listed below are given free with National Union tube purchases. Small deposit on some items. What do you need?

Supreme No. 333 Analyzer
 Hickok Simplex Tester
 Service Manuals—Auto Manual
 Triplett Oscillator and Output Meter
 Triplett Tube Tester

OTHERS SAY: "... Found National Union tubes have stood up with all tests and requirements as advertised."

*National Union Jobber Stocks Are Complete.
 National Union Tubes Are Sold by
 More Servicemen Than Any Other Make.*

National Union Radio Corporation of N. Y.
 400 Madison Avenue
 New York, N. Y. RC-13

Send me details about your offer for:

Name
 Street
 City.....State.....

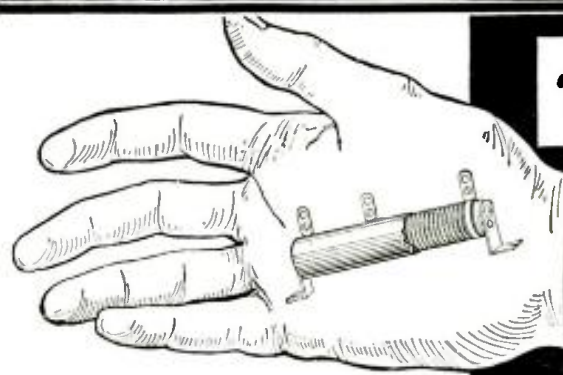

TRUVOLT

The Most Adaptable Radio RESISTOR

No Other Resistor Has These Features:

- Larger wire and patented air-cooling mean long life.
- Double spiral winding insures better electrical contact.
- Sliding Clips permit accurate voltage adjustments.
- 1,000 volt insulation and fibre protective guard.

All Standard Sizes.

FREE ●
 Write Dept. RC-1 for Catalog and Vest-Pocket Volume Control Guide.

The Most Adaptable Replacement **VOLUME CONTROL**

Standard covers instantly interchangeable with power-switch assembly. Long, easily-cut ALUMINUM shafts. Only five types will service 799 receiver models.

SERVICEMEN...



**HAS
O. M. P.
GOT
YOU?**

Is Old Man Procrastination holding you back? Are you only WAITING for things to get better—or are you hard at work MAKING them better?

"Practical Mechanics of Radio Service" is a NEW system that will be of untold help to ANY serviceman who is willing to invest \$10 and a little time in inspiring HIS FUTURE. Prepared by F. L. Sprayberry, prominent service engineer. It is the MOST HELPFUL plan ever offered—a time-saving, money-saving post graduate digest for the active serviceman.

Every new development—every modern method and type of servicing is detailed. Besides complete, easy descriptions of practically every modern means of Set Testing, Repairing, Parts Testing and Trouble Shooting, there is a special section on tubes and another on making, modernizing and using Set Analyzers. At \$10, it is a plan you can't afford to miss.

Write for details. Don't follow! Make competition follow you!

F. L. SPRAYBERRY

132 Bryant St., N. W. Washington, D. C.

F. L. SPRAYBERRY 132 Bryant St., N.W. WASHINGTON, D. C.

Please rush—FREE—complete details of Practical Mechanics of Radio Service, your new advanced training system for modern servicemen.

Name

Address

City State

WANTED!

Jobbers—Mail Order Houses and Representatives in all Territories

TWO FAST MOVERS



Free Edge Cone and Voice Coil Assemblies
We also Manufacture Various Types of
Magnetic Speakers
We can Supply and Remedy Your Speaker Needs.
Speaker Mfrs. Since 1921

LEOTONE RADIO CO., 63 Day St., New York, N.Y.

Sensitivity **SHURE** *Tone Quality*
MICROPHONES
SHURE BROTHERS COMPANY
Manufacturers of MICROPHONES Telephone 311-0000
315 WEST HURON ST. CHICAGO, ILLINOIS

World-Wide Two Tube Short Wave Receiver

12,500 Mile reception record established! Tunes from 15 to 200 Meters. Gets foreign broadcasts, police calls, airplanes, amateurs, etc. DIRECT! Complete KIT (no drilling) with clear instructions to build this remarkable 2 tube receiver.....\$4.75 try coil or AC model. Send \$1.00. Balance C.O.D. Satisfaction Guaranteed! NOT a toy!
NOT an attachment! A REAL, complete, all-wave receiver.
Harrison Radio Co., Dept. R1, 142 Liberty St., N. Y. C.

JUST OFF THE PRESS!
Free MAKE US YOUR HEADQUARTERS for PUBLIC ADDRESS AMPLIFIERS
1934 RADIO AND AMPLIFIER CATALOG Deal DIRECT with Manufacturers and SAVE BIG MONEY.
COAST TO COAST RADIO CORP.
121-12 WEST 17th ST., NEW YORK, N. Y.

MAKING TRANSFORMERS

(Continued from page 409)

used in low-impedance circuits are "pi" wound.

The reader would undoubtedly be interested in the more practical transformer construction such as could be used in building up special units to improve upon the quality of amplifying equipment already at hand or to repair burned out units. It is encouraging to know that with reasonable care and with the use of standard grades of core material, transformers can be built with a response curve essentially flat from 30 to 8,000 cycles (which response is as good as many transmitting stations can boast of at the present time).

First, it is very strongly recommended that the reader not try to make his own core, but purchase it from a reliable manufacturer. Thin laminations should be specified, preferably No. 29 gauge. These are stamped out with sharp dies and are annealed afterwards to retain a high degree of permeability. Such core material is obtainable in various sizes from a number of reliable houses, and it can be purchased at very reasonable prices. These laminations can be obtained in either the butt joint or the lap joint type and for easy construction the lap or interleaved joint is the most simple to build up and mount. Inasmuch as it is of paramount importance to have a high-grade core material, it is not advisable to use old cores unless they are known to be of high quality.

Winding Considerations

Now we are ready to prepare the windings. If the unit is to carry D.C. through its winding (this is not recommended except when push-pull amplification is used where the effects of the currents neutralize each other) the wire must be large enough to carry the current without heating. Allow approximately 1,300 c.m. (circular mils) per ampere; the correct size can be ascertained by looking up the wire size in a wire table. (See RADIO-CRAFT references, below.—*Technical Editor*). In windings where no D.C. flows the wire can be very small—from No. 36 to No. 40 gauge. For practical construction it is advisable to use single sections on both the primary and secondary windings except where the transformer works into a very high impedance, and in that case the high impedance winding can be wound in two sections. Double cotton covered (D.C.C.) wire should be used on all windings except those designed to work into very low impedances such as the voice coil of dynamic speakers, in which case plain enameled wire is satisfactory. Before the windings can be made, the dimensions of the core must be known.

Trim a soft wood block to the size of the core upon which the windings are to be placed and cut to a length such that it can be mounted conveniently in a lathe or a winding jig. Then wax the block with beeswax or paraffin so that the finished winding can be slid off without causing damage to the windings. We are now ready to begin the construction proper.

Cut a thin piece of cardboard to the correct winding width, allowing 1/16-in. clearance between the sides of the core and the finished winding. Wrap the cardboard around the winding block and cut to a length such

that the ends lap 1/4-in., then glue the ends of the lap to hold them in place. This not only provides a substantial base for the winding but also prevents injury to the insulation while the core is being built up within the winding. Wrap the cardboard with thin empire cloth or heavy waxed paper. This can be held in place until the winding is started. Cut a narrow strip of friction tape about 1/2-in. long and lay it lengthwise on the coil form at the end where the winding is to start and in such a position that the first turn comes in the center of the strip.

Wind two or three turns and then pull the free end of the tape back tightly over the turns and continue winding over the tape. This binds the first few turns and prevents the windings from slipping. The same procedure is used at the end of each layer of the winding. In the event that the winding has to be tapped, the turns-per-layer and the total number of turns can be varied slightly so that the taps will come from the outside turns. When the primary is completed, it is wrapped with two or three layers of waxed paper and then the secondary can be wound on it in the same manner as the primary.

When a static shield is desired, a strip of the thinnest copper obtainable, cut to a width slightly less than the width of the windings, is used. It is cut to a length such that the ends lap 1/4-in. Place a piece of empire cloth or its equivalent between the lapped ends so that under no condition will contact be made between the two ends (which would cause a short-circuited turn). Before this shield is put in place, a small wire or strip can be soldered to it enabling it to be grounded to the case. With the static shield in place, wind about two more layers of waxed paper around it to insulate the secondary winding from the grounded shield. The winding operation can then be continued.

When the windings are completed they should be well wrapped with tape to keep them in place. The coil should now be impregnated to drive out all the moisture. This is done by boiling slowly for approximately 15 minutes in beeswax with a small amount of resin added.

Assembling the Transformer

The unit is now ready to be assembled. Build up the core on the coil, using great care not to cut into the winding with the sharp edges of the laminations. If the core is to be bolted together, small brass bolts should be used. Several methods of mounting A.F. transformers are also shown. (A very simple and effective method of mounting—not illustrated—is to place the unit in a metal case and seal it with a hot resin compound.)

Inasmuch as the theory of transformer design has been covered in earlier issues of RADIO-CRAFT ("The Design of Power Transformers," by C. W. Palmer, Sept. 1931, page 166; "The Theory and Construction of Volume Controls, Line Filters and Matching Transformers," by Henry Levy, Part I, May 1932, page 660, and Part II, June 1932, page 727.—*Technical Editor*) it will be reviewed only enough to recall the important factors.

The impedance ratio of windings varies, as the square of the number of turns; therefore, if a transformer is to match two impedances, the turns ratio of the unit will be the square-root of the impedance ratio. The impedance of a winding varies directly with the cross-sectional core area. Now, knowing the above

TABLE II (Average Design Factors of a Series of Standard A.F. Transformers)

Purpose	Impedance Ratio	Primary Turns	Secondary Turns	Core Size (X-Section)	Wire Size	Notes
Single 2A3 to 10 ohms...	2,500/1	1,580	100	1.25 sq. in.	No. 33 D.C.C.	Parallel feed with 30-lb. choke
P.-P. 2A3's to 10 ohms...	5,000/1	2,236 C.T.	100	1.25 sq. in.	No. 32 D.C.C.	Wind pri. in two sections.
P.-P. 2A3's to 4,000 ohms	5,000/4,000	2,236 C.T.	2,000	1.25 sq. in.	No. 32 D.C.C.	Wind pri. in two sections.
Single 250 to 10 ohms...	4,350/10	2,085	100	1.25 sq. in.	No. 32 D.C.C.	Parallel feed with 40-lb. choke.
P.-P. 250's to 10 ohms...	17,400/10	4,170 C.T.	100	1.25 sq. in.	No. 32 D.C.C.	Wind pri. in two sections.
P.-P. 250's to 500 ohms...	17,400/500	4,170 C.T.	707	1.25 sq. in.	No. 32 D.C.C.	Wind pri. in two sections.
P.-P. 45's to 10 ohms...	18,400/10	4,750 C.T.	111	1 sq. in.	No. 33 D.C.C.	Wind pri. in two sections.
P.-P. 45's to 4,000 ohms...	18,400/4,000	4,750 C.T.	2,220	1 sq. in.	No. 33 D.C.C.	Wind pri. in two sections.
200 ohms to 50,000 ohm Grid.....	200/50,000	500	7,900	1 sq. in.	No. 36 D.C.C.	
500 ohms to 500 ohms...	500/500	886	886	8 sq. in.	No. 34 D.C.C.	
200 ohms to 200 ohms...	200/200	560	560	8 sq. in.	No. 34 D.C.C.	
500 ohms to P.-P. 15,000 ohm Grids.....	500/60,000	796	8,650 C.T.	1 sq. in.	No. 36 D.C.C.	Wind sec. in two sections.
Type 56 to Grid.....	25,000/100,000	5,600	11,200	1 sq. in.	No. 38 D.C.C.	Wind sec. in two sections.
P.-P. 56's to P.-P. Grids...	75,000/100,000	9,750 C.T.	11,200 C.T.	1 sq. in.	No. 38 D.C.C.	Wind both pri. and sec. to two sections.

FREE A 1¢ postcard brings it 1934 CATALOG FORDSON RADIO SAVE 1/3 to 1/2

New, free catalog of latest 1934 models is the greatest display of VALUES—in performance, appearance, price—we ever offered! See for yourself the reasons for Fordson popularity around the world—why J. Trainor, N. M., writes: "You are doing for Radio what Henry Ford did for Auto industry—Not how cheap but how Good!" Big, free catalog shows you a set to answer every requirement, from 15 to 2400 meters; AC-DC; battery; long and short wave; all-wave supers; 6 and 32 volt; consoles, and all-electric auto radio. Fordson includes 4 to 7-tube sets for home, camp, car, farm and export—from 2000-mile midgets that get police calls to all-wave sets that span the world. Guaranteed. 30-DAY FREE TRIAL IN YOUR HOME. Prices \$8.95 up will amaze you—from \$8.95 up. Get your copy of this remarkable catalog. Send a postcard or coupon TODAY!

ANY SET
ON
30-DAY
FREE
TRIAL



4-tube AC-DC



4-tube Dual Wave



7-tube All-Wave



6-tube All-Electric Car Radio



32-volt All-Electric Adapter

MAKE MONEY as our agent. No experience needed. Sales plan with REAL COMMISSIONS. 2-color literature, cards (with your name) all FREE. Agent's sample sets FREE. Write today!



FORDSON RADIO MFG. CO.
Dept. 1, 11700 Livernois Ave.,
Detroit, Mich.

Send me the New, FREE catalog and agent's plan.
Name
Address
City State

BACK ISSUES OF RADIO-CRAFT

which you might need to complete your files, can still be had at the price of 25c per copy. Send us your requirements, together with your remittance in check or money order.

RADIO-CRAFT

96-98 Park Place New York, N. Y.

GET THE BIG RADIO CATALOG

THE RADIO SUPPLY WORLD IN 148 BIG PAGES just out for 1934. Make your request for it on your dealer's, Service Man's, School's, Experimenter's or Amateur's letterheads. Order from America's Largest Radio House in America's Handiest Shipping Point.

BURSTEIN-APPLEBEE CO.
Dept. A-3 1012 McGee St. KANSAS CITY, MO.

YOUR OPPORTUNITY— THEATRE SOUND EQUIPMENT

Buy From the World's Largest Suppliers
Exceptional Bargains in New, Used and Rebuilt Motion Picture Apparatus. Recent Government Surplus and Liquidation of other manufacturers, such as PACENT, ROYAL AMPLITONE, POWERS CINEPHONE, TONE-O-GRAPH, BIOPHONE, RCA PHOTOPHONE and others now offered to our trade.

Write for Our New Illustrated Catalogue
S. O. S. CORPORATION
Dept. RAC 1600 Broadway, New York, U.S.A.
EXPORT: 120 Liberty St., New York
CABLE ADDRESS: "SOSOUND" New York. All Codes.

FREE 1934 RADIO CATALOG

BARGAINS GALORE FOR
DEALERS — SERVICEMEN — AMATEURS

TRY-MO RADIO CO., Inc.

85 CORTLANDT ST., Dept. C-1, NEW YORK CITY

which is tuned by moving the iron core, thus eliminating the usual tuning condenser.

We have known for many years that as soon as a piece of iron is placed inside the magnetic field of a coil, the inductance rises. However, it has only been recently that several new iron cores, for use in high-frequency circuits, have been developed. (Such cores consist of finely divided particles of a special grade of iron, all very carefully insulated from one another and molded to form a solid core material.)

This means that we can now vary the wavelength by means of an iron core moving in and out of the tuning coil, without the losses that previously prevented this system being applied to high-frequency circuits.

The real advantage, apart from the practical eliminating of the tuning condenser, is twofold: first, it becomes possible to reduce the number of turns in the coil, and thus cut down the high-frequency resistance; second, the coil has a constant efficiency at all wavelengths in each wave-band.

A two-tube set, the circuit of which is shown in Fig. 6, was constructed to test this new coil, experimentally; two types of coils are shown as L1, L2. The loudspeaker connects at L.S. In order to cover both wave-bands, some form of switching was needed. The circuit shows a special switch, Sw.1, Sw.2, for selecting the wavelength range; and another Sw.3, for cutting out part of the regeneration on long waves. The results obtained with this set were superior to the usual two tube set, both in sensitivity and selectivity over the entire wave-band. (European sets are ordinarily made to cover two wave-bands as some of their broadcasters operate on wavelengths above the ordinary, of 200- to 550-meter broadcast band.—Associate Editor).

A RADIO "GROWLER"

(Continued from page 399)

Locating Concealed Wire or Pipe

Move the search coil about until the maximum volume point is found. The return circuit must not be near the conductor to be located. The distance from conductor to search coil is rather limited. (Fig. 4-15.)

Alternative for medium- or high-resistance lines or circuits.—The resistance of the circuit must be high enough to prevent shorting the buzzer. This method shown in Fig. 4-16, often gives more volume and greater distance than test No. 15.

Locating One of a Number of Insulated Conductors

Separate the wires of the cable and test one at a time with the search coil. When the search coil is close to the required conductor, a buzz will be heard in the phone. (Fig. 4-17.)

Alternative.—Use the method illustrated in Fig. 4-18 for medium- or high-resistance circuits. If necessary use method No. 12 to find the ends. When the search coil is close to the conductors, a buzz will be heard in the phone.

Alternative.—Use the method shown in Fig. 4-19 and Fig. 4-20 when no ground return is available. If necessary, pick a pair by method No. 13 or 14. Locate them at the search point with the search coil and tag or mark them.

Using these as return wires, locate other wires with the search coil. Using one of the other wires as the return lead, the pair may be separated and each isolated. Single wires are often distinguishable from pairs by a louder buzz.

Locating Grounded Point on a Wire

Move the search coil along the conductor; when the grounded point is passed, the buzz stops. The test is not practical where the return is through a metal sheath. Fig. 4-21.)

Alternative.—Use this method (Fig. 4-22) for medium- or high-resistance circuits. When passing the grounded point, the buzz stops. This test is not practical where the return is through a metal sheath.

Locating Short-Circuit

Use method 23 if a short is found to be present by test No. 1. Separate the wires a short distance and test with the search coil. Upon passing the shorted point, the buzz stops.

Alternative.—Use the method shown in Fig. 4-24 for medium- or high-resistance shorts, found by No. 1 or 2. Separate the wires a short distance and test with the search coil. The buzz stops when the shorted point is passed.

Radio-Frequency Generator

Try the "unilateral" connection of the buzzer to each side of the wavemeter, C1, L1, as shown in Fig. 4-25. The tone is not the mechanical sound of the buzzer, but has the frequency of the spark at the contacts.

Alternative.—Use three to eight turns, L2, close to wavemeter coil as shown in Fig. 4-26. Many arrangements using coils and condensers and connected to different terminals on the buzzer are possible.

Signal System

Telegraph communication can be carried on with the apparatus as shown in Fig. 4-27. A second wire may be used in place of the ground connection, G; if the buzzer (or buzzers) stops when both keys are closed, reverse the line wires at one end.

Alternative.—When the buzzer will not operate through the double line, or line and ground, the method shown in Fig. 4-28 will work. A second wire may be used in place of a "ground return."

In tests Nos. 27 and 28 use duplicate equipment at both ends of the line.

Special Considerations

In any of the tests described above where connections are made to terminals 1 and 3 of the buzzer, as in tests 1, 3, 5, 6, 8, 11, etc., the resistance of the circuit must not be too high, or the buzzer will not operate. The critical value for this resistance varies with different buzzers, the buzzer adjustment, and the number of cells used to supply the power.

In any of the tests where terminals 1 and 3 are connected together, and power is taken from terminals 1 and 2, as in tests 7, 12, 14, 16, 18, etc., the resistance of the circuit must not be too low, or the buzzer will be shorted; this will either entirely stop its operation, or shorten the life of the buzzer contacts and batteries.

The search plates or magnetic collector are suitable for tests 15, 16, and sometimes 21 and 22; and increase the pick-up distance. A double head-set will also help. The buzzer should either be located some distance away from the operator, or wrapped up to silence it, so that it will not interfere with listening. Its range should be sufficient to locate wires in average walls or ceilings. My set will do considerably more, locating a wire several inches beyond the "far side" of an ordinary wall.

In all tests where the search coil is used, the conductor cannot be in a pipe or BX cable, since iron acts as a magnetic shield. Often, however, the pipe or BX itself may be used as a conductor, and located. The search coil will also register on the return conductor with the other conductor, the magnetic fields of each will balance out, giving no indication. If the return is very close or twisted tions.

Addendum

(The author's article ends at this point, but the following information is added by the editors to clarify points which might confuse the less technical reader who is interested in constructing one of these units.)

The buzzer which is mentioned throughout the sequence of the tests was mounted on a small bakelite disc (about 3/16-in. thick) on which were also mounted the three small binding posts (made from the terminals of No. 6 dry cells) marked 1, 2 and 3 in Fig. 1 and in the tests illustrated in Fig. 4. This disc, which may be made from any insulating material such as bakelite, hard rubber or wood, is cut the same diameter (1 9/16 ins. in this particular unit) as the flashlight into

which it is inserted. As explained before, a notch about 1/2-in. wide is cut in the edge of this disc and the circumference of the flashlight case (at the "reflector end") is sawed to leave a flange of similar dimensions. This flange and notch prevent the buzzer from turning, so that the contacts will always be in the correct position.

As shown in Fig. 1, binding post No. 1 connects to the outside of the buzzer winding. Contact No. 2 connects to the inside of the buzzer winding and also to one of the vibrator contacts. The other vibrator contact is connected by a wire to a brass angle, mounted on the insulated base of the buzzer, in such a way that it makes contact with the central (positive) terminal of one of the two flashlight cells.

Terminal No. 3 on the buzzer mounting connects to a brass spring shown in Fig. C, about 3/8-in. long and 3/16-in. wide, which extends along the side of the buzzer winding and makes contact with the "switch spring" in the flashlight. (This "switch spring" normally contacts the metal reflector and lens-retaining ring.) This is shown schematically in Fig. 1. The details of this construction, of course, depend upon the buzzer used and it is only necessary to follow the wiring shown in Fig. 1 in order to obtain the correct action.

In tests 15 to 24 inclusive (Fig. 4) the search coil is used. This coil is shown at the right of Fig. B and details are illustrated in Fig. 2. The action of these tests depends upon the presence of a magnetic field around any wire or conductor in which alternating or fluctuating current is flowing. In the tests mentioned above, the buzzer is connected through the wiring system in question to ground, and when it is used correctly, the buzzer works continuously. This sets up the magnetic field which is picked up in the search coil and transmitted to the phone. When the search coil is brought close to the wire carrying the buzzer signal, the sound in the phone increases in amplitude. This is the basis upon which all the tests with the search coil depend. The iron search coil plates described, and illustrated in Fig. 3, merely increase the effective area of the "poles" of the search coil to make the latter still more sensitive. When the search coil unit (made as per Fig. 1) has been completely taped and varnished it will just "plunk" snugly between the two, short, vertical wings on the search coil plates; the coil cores should butt onto the faces of the two plates.

In tests Nos. 21 to 24 inclusive in which the search coil is used to locate a "ground" or "short," the buzz stops when the search coil approaches the grounded point; the sound ceases because, at this point, the signals from the buzzer naturally are at ground potential and for this reason they cannot be picked up in the search coil and phone.—*Editors*)



"Clean and balance the set."

The NEW Ultra-Deluxe LINCOLN

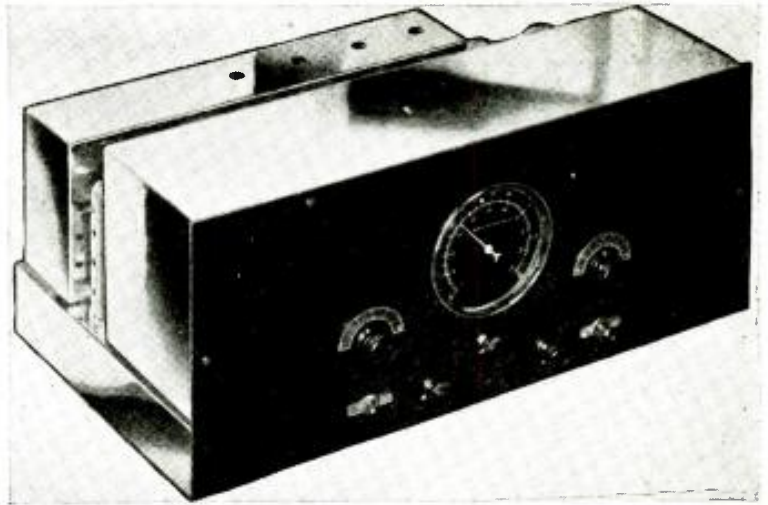

REVOLUTIONARY IN EVERY FEATURE

*From Antenna to Output
Single or Double Audio System with New
Lincoln-Hutter Diffusing Columns*

*Write for complete details
before placing your order
for any other receiver.*

Lincoln Radio Corporation

2222 Diversay Avenue
Chicago, Ill.

One Year's Guarantee Against Obsolescence

Edco Tube Tester \$32.00 NET

Tests All 4-, 5-, 6- and Dual 7-Prong Tubes

It's Outstanding Characteristics Are:

- DIRECT ENGLISH READING
- 4 Sockets
- Short Test
- Gas Test
- Tests 2nd Plate
- Line voltage adjustment on 1000 ohms per volt, copper oxide A. C. Meter.
- Beautiful veri-chromed bakelite panel. Mounted in handsome carrying case. Dim., 8 1/2" wide, 12" long, 5" deep.
- 3 Selectors
- Cathode Heater Leakage
- Emission Test
- Tests 2nd Diode

LITERATURE SENT UPON REQUEST



Equipment Design Co. - Hot Springs, Ark.

ULTRA MODERN SET ANALYZER

The finest—most handy analyzer that can be built. Simple to operate with accuracy. Designed by C. Sicuranza.

KIT PARTS, CARRYING CASE & BLUEPRINT \$59.50

KIT ASSEMBLED \$62.50

ANALYZER ASSEMBLED & WIRED \$77.50

You can work faster with this Ultra Modern Analyzer and accomplish more practical work.

SEND FOR BOOKLET

JORDAN RADIO MFG. CO.

Makers of Fine Instruments
30 MYRTLE AVE., BROOKLYN, N. Y.



SERVICEMEN

Why be handicapped with an ancient analyzer when in two hours you can easily modernize it with one of these kits and a pair of composite sockets! Directions and diagrams included with all outfits.



Here is the professional model. Used on the latest Weston-Jewell, Hickok, Supreme, etc. testers. If you want the best get this kit. Has the famous NA-ALD Latch-Lock with thumb release. 907WLA New small 7-prong Latch-Lock Analyzer Plug List with Twin C.G. Handle. \$3.50

976DA 7A to 4-prong Latch Adapter	1.25
975DSA 7A to 5-prong Latch Adapter	1.25
976DSA 7A to 6-prong Latch Adapter	1.25
977DSA 7A to 7-prong Latch Adapter	1.25
907WLA KIT Complete as shown	\$8.50



Here is the set for those who want the lowest possible cost. Does not have means for locking the adapters to the plug but is serviceable in every way, the wired adapters having the necessary small base for fitting shielded sockets. C. G. stud supplied.

977P 7-prong Plain-Type Analyzer Plug	\$.40
974W 7 to 4-prong Wired Adapter	.55
975W 7 to 5-prong Wired Adapter	.55
976W 7 to 6-prong Wired Adapter	.55
977WA 7 to 7A-prong Adapter	.55
977P KIT Complete as shown	\$2.60

8-Wire Braid-Covered Analyzer Cable. List 10c. ft. 456 4-5-6 Contact Composite Socket. List 50c ea. 477 7-7 Contact Composite Socket. List 50c ea.

It's here at last!—The "Make-Your-Own" Adapter Kit. All the parts for making any required adapter, including all ten types of socket top-sections and small sized base-sections complete with over two dozen assorted extension, soldering, connection, phone-tip and control-grid terminals, connectors, clips and lead wires. 900 "Make-Your-Own" Adapter Kit complete. List \$2.50 Bought separately each 4, 5, 6, 7 and small 7 top of base section lists at 45c each.

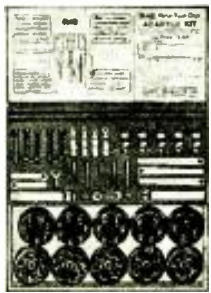

HERE'S HOW TO MODERNIZE YOUR CHECKER



List \$6 950XYLA Checks over 120 new tubes including small 7's in your present tube checker. If checker has no fil. voltage with adapter 9548GL, list \$1.25 is also required. Servicemen's discount 35% on orders listing at \$10 or more. 40%.

List \$6 950TR Checks ALL 10 to 30 volt filament tubes in the 21 tube checker socket with 2½ volts filament voltage selector switch and internal transformer.

HERE'S THE DATA YOU WANT

Send two 3c stamps for new 16 page booklet showing illustrated tube socket connections of 268 different tubes, data and diagrams on rewiring any obsolete set analyzer or tube checker and information on using the new tubes in place of old types. Includes catalog pages on all kinds of sockets, speaker plugs, connectors, wound and unwound coil forms, coil winding data, S-W receiver references, etc.

ALDEN PRODUCTS CO.



Dept. R-1, 715 Center St. BROCKTON, MASS.

RADIO BEGINNERS "PIANOTRON"

(Continued from page 405)

Such an apparatus is described here.

The Circuit

The circuit is very simple and should cause no difficulty. OTHER CIRCUITS (for the same number of notes and power output) ARE MUCH MORE EXPENSIVE TO BUILD. Referring to Figs. 1 and 2, we see that it employs a 30 tube as a variable R.F. oscillator. The tuned circuit for this oscillator consists of an ordinary broadcast-type coil designed for use with a 350 mmf. tuning condenser; the capacities C1, C2 and the 16 small condensers (home made) each connected to its own key, are used in our "radio piano." The capacities C1, C2, totalling .002-mf., tune this R.F. oscillator to its base radio frequency of about 230 kc. for zero-beat with the other R.F. oscillator and each of the 16 small condensers each add enough capacity, when its respective key is pressed, to change this frequency by some value which will produce an audible change.

The second R.F. oscillator consists of the fixed-tune circuit L2, L3, L4 and C6 coupled to the oscillator section of the type 1A6 tube, V2. The plate of V1 is coupled to the control-grid of the pentode section of this 1A6 tube. Due to the fact that this control-grid and the oscillator grids are in the same electron stream this results in ideal coupling between the two frequencies since there are no capacities or inductances involved in the process and no tendency for the two oscillators to "pull together" as they invariably do when coupled by such devices.

The plate of the 1A6 is resistance-coupled to a type 33 tube, V3, used as an audio amplifier feeding the loudspeaker.

Bias voltage for the control-grids of the 1A6 and the 33 is obtained from the potentiometer R7 in the negative "B" supply line.

Construction

Very little need be said regarding the actual construction of the device, for the layout is very clearly shown in the photographs and picture diagram. The construction, once the parts are all made, is straightforward and simple. A "breadboard" layout was followed in this design for the same reason that it was used in previous "Beginner's" designs—to wit, simplicity of construction.

The first job to be tackled is the making of the 16 keys of which a detail sketch is given in Fig. 2. They had best be made of some hard wood, sandpapered smooth and given a coat of shellac or varnish for appearance.

The shelf on which the keys and tuning condensers are mounted is next made by screwing two 3 x 3 ins. end pieces on a board 3 x 12½ ins. long. On top of this shelf is mounted the common plate of the tuning condensers—a piece of 1/16-in. metal 2½ x 12½ ins. held in place by two rows of nine screws (8 spaces), one row along each edge. Between the metal and wood shelf are placed several thicknesses of heavy drawing paper, preferably waxed.

Now mount the 16 keys on a ½-in metal rod long enough to extend through the end pieces of the shelf. Put a washer between each key and its neighbor. Along the back edge of the shelf, underneath, mount 16 small screws so spaced that they will make contact with the screw heads in the keys when the latter are properly mounted. Under each one of these screws fasten a pigtail lead having a free length of about 2 ins. from the edge of the shelf when every other lead is brought to the front of the shelf.

Mounting the bank of keys on the shelf is simple enough but, if a nicely operating assembly is desired, rather tricky and requiring careful workmanship. The keys are mounted by passing the rod on which they are hung through a hole in each shelf end but this hole must be very carefully located so that when a key is horizontal it does not make contact between its screw and the corresponding one in the shelf, but so that by pressing the outer end down about 3/16-in., a good contact is made. After this position is found (and heed the warning to work slowly and surely here for if the holes are just a little off they cannot be moved) make

a small metal bracket to be screwed to the underside of the shelf and having a hole of the proper height to support the center of the key shaft.

Now mount the rod, keys and bracket in place and directly under the saw slots in the keys mount another rod about ¼-in. from the bottom edge. Between each key and this rod is stretched a rubber band to return the key to the off position. Along the underside of the shelf in front is mounted a piece of wood just thick enough so that the keys stop against it in a horizontal position. Solder the pigtail lead from each key to this rod (be careful not to burn the rubber bands in this operation) and solder a ground lead to this rod.

The "Note Condensers"

Now make up 16 condenser plates of metal about 1/64 x ¾ x 1¼ ins. long with one end turned up about 1/16-in. A detail of one of the "note condensers" is Fig. 3. Solder this turned up end to each of the 16 pigtail leads brought out from the screws under the shelf (by the way, make sure that these screws do not come through the shelf or they will short out the tuned coil and prevent operation of the oscillator) and slip the long end between the waxed paper and the shelf, placing one "note plate" between each pair of screws holding down the common plate. Before placing the "note plates" in position go over the edges of these plates with a fine file or emery cloth to remove any sharp points which might cut the paper insulation.

On each end of the shelf supports mount an angle bracket to permit the whole assembly to be screwed to the baseboard and the unit is ready to mount in place when the other apparatus is wired up.

In the approximate center of the front, vertical baffle board cut a hole large enough to take the speaker you intend to use, mount the speaker and fasten the whole arrangement to the front edge of the baseboard with a couple of small shelf brackets, as shown.

Now proceed to mount the oscillator coils, tube sockets and condensers in the positions indicated by the photographs and picture diagram, and wire up these components. Then mount the keyboard assembly and make a connection as shown from the rod to ground (or negative filament) and from the top plate to the grid side of coil L1.

Operation

Place the tubes in their sockets and connect up the "A" battery to the power plug. Putting this in place should result in all tube filaments lighting up with a dull red glow. Then, just to be on the safe side, take out all but the type 30 tube, V1 (that's the cheapest one of the lot) and make a quick, snappy connection to the "B" supply. If nothing in particular happens we know, at least, that the "B" is not shorted to the filaments. If, however, the tube should give a beautiful, bright light for about a tenth of a second you know that there is a short, and it only cost you the price of one tube to find it out!

Assuming that everything is O.K., make this "B" connection permanent and put a milliammeter (25 ma. or larger) in the "B" cir-

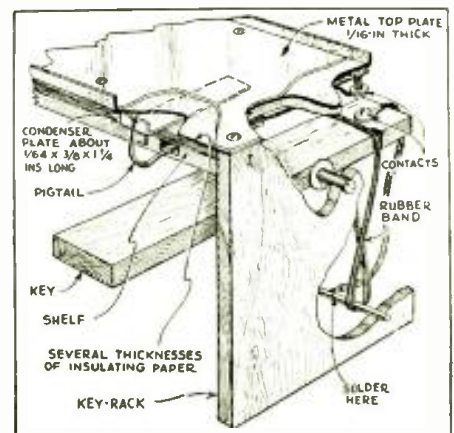

FIG. 3

Detail view of one of the "note" condensers.

Triplet Meters

are rapidly making a name for themselves as quality instruments at popular prices. We carry the complete line at regular wholesale prices. Call or write for descriptive bulletin.



45D VESEY STREET New York, N. Y.

cut. Shorting out the tuning coil L1 with a screwdriver should result in a change in the reading of this meter. If it does not, the tube circuit is not oscillating. Reverse the connections to the plate coil and try again. If it still shows no change, carefully check over the entire circuit for the fault which exists somewhere.

Remove the type 30 tube and put the type 1A6 tube, V2, in the correct socket, first being sure that the slider of R7 is in its most negative position—to the right, on the schematic diagram, Fig. 1. The same change in plate current will be noted for this tube—though much smaller in amount—when the coil L2 is shorted out, if this tube circuit is oscillating. Try turning L3 (the normal tapper coil) to all possible positions. If circuit oscillation is not obtained reverse the connections to L4 (the normal primary) and try again. If the circuit still doesn't oscillate, check the circuit.

Be rather careful with tube V2 as it is somewhat delicate; under no circumstances should the total "B" current through the tube be more than 9 ma.

If you have no milliammeter and can't borrow one for the occasion, we can use our old standby—the broadcast receiver—to check for oscillation (though, in this case, as the tuning of one oscillator is not variable and the other one not greatly so, it is rather a tedious method).

Use a regular tuning condenser—350 mmf. or 500 mmf.—and connect it temporarily across L1 and L2 in turn. Then tune in a station on the broadcast set and run a wire from the control-grid connection of the 1A6 tube to the antenna post of the set. (The control grid is the top cap.) This same connection holds for testing both tubes.

Now swing this temporary tuning condenser around the dial. If you are lucky you will hear the squeal that indicates oscillation. If not, you will simply have to try all possible combinations of various broadcast stations, positions of the tuning condenser and connections for the coil until you do get results. Test one tube at a time, as before.

Tuning

After you have checked both tubes for oscillation unhook all temporary connections and put all tubes in their sockets. With a stick of wood, sharpened to a screwdriver edge, screw the adjustment of C2 slowly up and down. The slider of R7 should be about three-quarters of the way toward the positive end during this operation. At some position of this screw you should hear a squeal going down and then up the scale. Adjust C2 to a point about in the range to which you wish to tune the instrument and adjust the slider of R7 to the point of maximum response, then leave it alone.

If you do not get this audio squeal there are two possibilities (since we know that both oscillators are working): (1) either the circuits associated with V3 are incorrect; or, (2) our oscillators are not tunable to identical frequencies. The first point can be checked by connecting a phonograph pickup across R2; the second by putting our temporary tuning condenser again across L1 and varying it. If we can get results this way it means that C6 is 'way off its correct value and must be replaced.

Now, with everything in order, turn the screw on C2 until you get the squeal going down the scale and up again, then carefully adjust it to dead beat—or no sound—between these two. Pressing a key should now result in an audible note and you are ready for the process of tuning.

If you have a good musical ear this can be done by ear, otherwise you had better use a piano as a standard. Adjust all the screws in the common condenser plate until you can just slide the tuning—or "note"—plates in and out. You can start your tuning in any octave you desire; the further in the plates are pushed the higher will be the pitch. If you cannot reach a sufficiently low note to start with, trim off some of the plate until you can reach this note with the plate pushed about three-quarters of the way in (so that it will stay in place). Trimming the note plates in the form of triangles will be found best.

Having started the process it is simply a case of cut and try until the entire keyboard is tuned. Tuning each key of our completed

"Pianotron" to the full tones of the piano will give a range of 2 octaves; tuning to the half-tones (the black keys on the piano) will give about 1½ octaves—more than the range of the "average" voice.

That's about all there is to say. It only remains to pick out your one-finger tunes, to the plaudits (?) of friends and family. Of course, if you are real ambitious you can build more keys—any number you desire up to the full piano range of 88 notes.

Experiments

The range can be extended in another way which, however, would require considerable practice to use expertly. Depressing two or more keys, by adding capacity, increases the pitch above that of one alone. It is quite possible to find combinations of keys that will increase the range at least another octave. Half-tones also, can be reached in the same way. Special music could be written for using the instrument (blank scales are available at any music store) in which a tone is represented not only by a single note but by two or more, each representing a key, tied to the same staff.

As the instrument is now laid out it produces a fairly pure tone which can become somewhat tiresome. However, the pentode tube, improperly operated in an amplifier sense, is a notorious producer of harmonics. The production of these harmonics depends on the load resistance (the loudspeaker), and the control-grid and screen-grid voltages.

Using another potentiometer of about 5000 ohms placed between R7 and the negative side of the line, and bringing the grid return of V3 to its slider will permit varying the bias on this tube.

Incidentally, if the bias resistor mentioned is used it might be necessary to add another section of "B" battery to make up for the drop across it or else the R.F. oscillators may fail to function.

Finally, this particular set-up is of a simple experimental nature; as a musical instrument it of course leaves much to be desired. However, there is in process of design a much more elaborate instrument in which it will be possible to play several notes at once and which will have a greatly extended range; and provisions for varying the tones produced, also power enough to cover a large audience. Any composition written for piano or organ can be played to its full beauty on such an instrument. If sufficient interest is manifested it will be built and described. What do you say? If you want it you will get it.

Parts List

- One 2-circuit tuner, any standard broadcast type, L1;
- One 3-circuit tuner to match the above, L2, L3, L4;
- One R.F. choke, L5;
- One mica condenser, .0015-mf., C1;
- One mica condenser, .002-mf., C6;
- One mica condenser, .001-mf., C4;
- Three mica condensers, 500 mmf., C5, C7, C11;
- One mica condenser, .005-mf., C8;
- One XL Variodenser, C5, 500 mmf. max., C2;
- One paper condenser, .1-mf., 200 V., or more, C3;
- One paper condenser, .5-mf., 200 V. or more, C9;
- One electrolytic condenser, 25 mf., 25 V., C10;
- Two resistors, ½-W., 50,000 ohms, R1, R4;
- Three resistors, ½-W., .5-meg., R2, R5, R6;
- One resistor, ½-W., 25,000 ohms, R3;
- One wire-wound potentiometer, 1000 ohms, R7;
- One midget magnetic loudspeaker;
- One type 30 tube, V1;
- One type 1A6 tube, V2;
- One type 23 tube, V3;
- Two 4-prong sockets;
- One 5-prong socket;
- One 6-prong socket;
- One 4-wire power cable and plug;
- One baseboard, 11 x 15 x ¼-in. thick;
- One baffle, 10½ x 14 x ¼-in. thick;
- Three 45 V. "B" batteries;
- One Rechargeit 2 V. storage cell;
- Sixteen rubber bands for key returns;
- Thin sheet stock for tuning plates;
- 1/16-in. stock for condenser plates;
- ¼-in. laminated wood stock for keys and key mountings;
- Angle brackets, wire and hardware.



Complete TESTING Laboratory in One Case!



Tester No. 1179

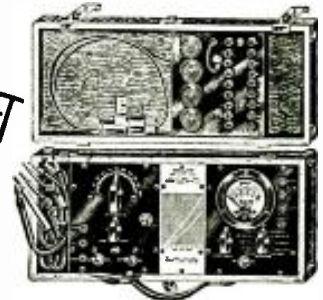

Now you can carry a complete and compact laboratory with you and solve any testing problem . . . without having to guess what the trouble may be. This new Triplet portable laboratory, No. 1179, consists of three units: 1150 Oscillator, 1125 Volt-Ohm-Milliammeter, and the 1166 Free Point Set Tester.

No. 1150 is a well designed, completely shielded oscillator. A switch permits generating either a stabilized modulated or unmodulated signal of constant level. Extremely accurate scale divisions cover fractional frequencies from 110 to 1600 K.C., on the individually hand-made chart.

No. 1125 contains a direct reading Ohmmeter, Output meter, A.C.-D.C. Voltmeter and Milliammeter. Complete with 16 different scale readings. All readings are controlled by a selector switch. It lends itself admirably to point to point continuity testing for set analysis and general testing.

The Free-Point Set Tester, No. 1166, is universal, flexible and is designed to overcome obsolescence. Four sockets take care of all present day tubes. Designed to overcome obsolescence.

YOUR JOBBER CAN SUPPLY YOU

... at the dealer's net price of \$34.67

See him today.

THE TRIPLET ELECTRICAL INSTRUMENT CO.

27 Main Street Bluffton, Ohio

Send Coupon for Facts

Triplet Electrical Instrument Co.,
27 Main Street, Bluffton, Ohio

Gentlemen: Send me catalog on Triplet Tester 1179 . . . and complete line of radio servicing instruments.

Name

Street Address

City State

HOW TO BUILD, TEST AND REPAIR RADIO SETS



Radio Construction Library

Including Television, Short-Wave Receivers and Auto Radios. 3 Volumes, 6x9—1177 pages, 561 illustrations.

This practical Library includes: PRACTICAL RADIO—The fundamental principles of radio, presented in an understandable manner. Illustrated with working diagrams. PRACTICAL RADIO CONSTRUCTION AND REPAIR—Methods of locating trouble and reception faults and making workmanlike repairs. Discusses modern Short-Wave Receivers and installation of automobile radios fully. RADIO RECEIVING TUBES—Principles underlying the operation of all vacuum tubes and their use in reception, remote control and precision measurements.

The Library is up-to-the-minute in every respect and is based on the very latest developments in the design and manufacture of equipment.

10 Days' Free Examination
Easy Terms

McGraw-Hill

FREE EXAMINATION COUPON

McGraw-Hill Book Company, Inc.,
330 W. 42nd St., New York.

Gentlemen—Send me the new RADIO CONSTRUCTION LIBRARY, all charges prepaid, for 10 days' Free Examination. If satisfactory, I will send \$1.50 in 10 days, and \$2.00 a month until \$7.50 has been paid. If not wanted I will return the books.

Name
Home Address
City and State
Position
Name of Company RC-1-34

FREE RADIO MANUALS

With every order of ARCO TUBES for \$10.00, or multiple thereof, you can get one, two or three 1934 Official Radio Service Manuals absolutely FREE. If you prefer, you can have copies of the 1934 Official Short-Wave Radio Manual FREE with orders for \$8.00 or both Manuals for orders of \$17.00. Remember that the regular list price of the 1934 Official Radio Service Manual is \$3.50, and the 1934 Short-Wave Manual \$2.50. This offer is subject to withdrawal without notice.

Your Cost	Type	Your Cost	Type	Your Cost	Type	Your Cost	Type
UX-201A	.30	UY-233	.85	48	1.10	UX-182	.85
UX-226	.30	UX-234	.85	49	.85	UX-183	.85
UY-227	.30	UY-235	.60	55	.60	UX-184	.85
UX-171A	.30	UY-236	.85	56	.60	UX-586	2.10
UX-120	.40	UY-237	.85	57	.60	UX-586	.85
UX-199	.40	UY-238	.85	58	.60	UX-401	1.50
UX-199	.40	UY-239	.85	59	.60	UX-403	2.00
UX-112A	.40	2A3	1.10	75	.85	UX-866	2.75
UY-224	.40	2A7	1.10	77	.85	UX-280	.40
UX-245	.40	2B7	1.10	78	.85	523	.85
UY-246	.60	6A7	1.10	79	.85	523Z	.85
UY-247	.60	6B7	1.10	80	.85	UX-281	1.10
WD-11	.60	2A5	.85	89	.60	UX-282	.85
WD-12	.60	41	.60	UX-210	1.10	UX-283	.85
UX-230	.60	42	.60	UX-222	1.10	UX-283	.85
UX-231	.60	43	.85	UX-250	1.10	UY-84	.85
UX-232	.60	44	.85				

Order from this advertisement—Remit 20¢ with order, balance C.O.D. All prices are F.O.B. FACTORY, Newark, New Jersey. Shipments go forward express or parcel post. No order for less than \$3.00 accepted. All tubes RCA licensed—6 months Guarantee.

ARCO TUBE CO. 38-40 PARK PLACE NEWARK, N. J.

REWIRE THAT OLD ANALYZER

Bring it right up to date. Our Blue Prints are for owners of the Weston 547, and is applicable to

WESTON 568
SUPREME 400 SERIES
JEWELL 408 AND 409

And Other Testers Using Three or More Meters. Blue Prints designed by Jack Grand consisting of Schematic, Panel, and Engraving Layout, List of Parts, Construction Details and Operating Instructions Complete..... \$1.60 Prepaid

SUN RADIO CO.
227 FULTON STREET NEW YORK CITY

SERVICING "TALKIES"

(Continued from page 408)

The Amplifier Racks

There are three amplifier racks shown in Fig. A, containing two complete amplifiers plus auxiliary equipment. Each amplifier consists of five stages in cascade. For the sake of convenience in shipping and repair, each amplifier is divided into three separate amplifier "panels," which mount on these racks. There are two of each type of amplifier panels.

Beginning at the upper left of these racks, just to the right of the fire extinguisher, there is a switching panel; the function of which in this particular installation the writer doesn't know. Below that is a blank panel, carrying no apparatus, installed to avoid leaving blank space on the rack. Below that are four amplifiers. The two nearest the top contain the first three stages of amplification. The tubes are inside the square cover that protrudes from the front of the amplifier, underneath the meters. This cover slides off and the tubes will be found mounted on rubber as a protection against microphonic noises, due to vibration of the floor. The dial at the left of this amplifier is the volume control. The dial at the right is the filament rheostat. These filaments are supplied by means of a 12 V. storage battery, filtered rectifier or motor-generator. (The same or another storage battery, rectifier or generator would supply the speaker field current if the horn cabinet previously described were not used.) The two meters read filament and plate current. The three buttons underneath the meters function to connect the plate meter into any one of the three plate circuits. The plate current is supplied by the rectifier, built into the amplifier, carrying the fourth stage and mounted on the rack immediately below.

These lower amplifiers, which contain the fourth stage of amplification, are shown at the bottom of the left-hand rack. They carry, on their face, four tubes (two rectifiers, two push-pull amplifiers) a meter, and a switch. The meter reads plate current. The switch is a "starting" switch, and has three positions. One is "off," the next supplies current to filaments only, the third, after the filaments have heated sufficiently, supplies plate current also. These filaments are lit by stepped-down A.C. The two right-hand tubes are full-wave rectifiers (three-element tubes with plate and grid shorted at the socket); the left-hand pair are Western Electric type 205's working with very conservative plate supply as Class A push-pull amplifiers.

On the two racks to the right of these are seen four amplifiers, all alike, which carry large, long tubes. These contain the final, or fifth stage of A.F. amplification. Two of these amplifying panels, wired in parallel, function as part of the "regular" amplifier; the other two, also in parallel, are part of the "emergency" set-up. Thus the fifth stage of amplification consists of four amplifying tubes—two push-pull stages connected in multiple. The external arrangement of these amplifiers is similar to that of the fourth stage just described. Each carries a starting switch with "off," "fil." and "plate" positions. Each carries a plate milliammeter, and four tubes on its face—a rectifier pair on the right and an amplifier pair on the left. These rectifying tubes are also three-element tubes, plate and grid shorted at the socket. The rectangular boxes underneath the tubes cover the filter condensers.

The auxiliary equipment is seen above these power stages. The top of the center rack carries a switching panel. This is for input, and connects this amplifier to sound (synchronized with the picture), to an announcing microphone, or to a non-synchronous phonograph, as desired. Bulls-eye signal lamps at each side of the two snap-switches show which type of input is in use and help prevent delays arising out of any mistake in switching. Directly below this panel is the speaker control panel, containing a tapped auto-transformer for matching the output impedance of this amplifier to any desired number of loudspeakers. Tap switches wired to the auto-transformer can be seen in two rows; four in the top row, three in the bottom row. Below each tap switch is a snap switch by means of which an individual speaker can be

removed from the circuit entirely. These snap switches are used each morning before starting the show, to test the stage speakers one at a time and make sure all are working properly. A snap switch under a guard, to the right of the lower row of tap switches, is a regular-emergency changeover, superseded in this installation by the switching panel just to the right of it, and therefore, no doubt, short-circuited.

Immediately to the right of this horn panel, and just below the row of meter jacks, is a double snap switch which cuts in either the regular or the emergency amplifier, as desired. Commonly one will be used on even days of the months and the other on odd days, to make sure both are always working perfectly. Tubes in both are kept lit and ready at all times while the show is running. Above this is a row of jacks by means of which a milliammeter may at any time be introduced into any of the speaker circuits. This arrangement permits checking the individual speakers for defects in the course of the show, without disturbing the audience. The meter, with its plug, can be seen mounted on the wall above, just to the left of the horn field control panel.

The Projection Equipment

The projection equipment, with the synchronized phonograph and photocell pick-up, and the drive motor, are shown in Fig. B. The three turn-tables behind each projector are easily distinguished. The pickup, or reproducer, can be seen just to the right of the turntable, below the needle-case. The disc turns at 33 1/3 r.p.m., and the pedestal on which it rests is provided with an elaborate spring-and-oil filter to insure steady rotation. The motor that drives both turntable and projector is seen just to the left. When the disc turntable is not in use, the rubber coupling between it and the motor is sometimes removed.

To the left of the motor may be seen an aluminum shaft leading upward to a polished flywheel through which power is applied to the projector. This flywheel is hollow, and has a system of filter springs inside it, to insure steady motion.

Speed of rotation is governed in this installation by a "control cabinet" which stands on the floor in front of the motor, but is not easy to distinguish in the picture. This cabinet (there are several types) may contain three or four vacuum tubes. A small alternator is coupled by a shaft to the drive motor, under the same shell. The control cabinet contains a frequency filter. When the speed of the motor changes, the frequency of the alternator output varies, and the tuned filter circuit in the control cabinet acts through the vacuum tubes to adjust the current supply of the drive motor. To describe the circuit in detail would take more than all the space allotted to this article. Several useful descriptions can be found in current books describing talking picture equipment. Just as it would be impossible to stop here to tell the wiring and functional details of an audio amplifier circuit, so it is—most unfortunately—impossible at this time to describe in detail another vacuum tube circuit, different but fully as complicated, used for controlling motor speed. The control is, within wide limits, independent of line voltage changes, and independent of the mechanical drag upon the motor.

To the left of the flywheel may be seen the casing which holds the photoelectric cell and its "private" amplifier. This amplifier serves the photocell alone; the disc pickup and the announcing microphone do not need any.

It may be well at this point to avoid confusion by saying just a word or two about the projection apparatus shown in Fig. B.

The large pipes leading up to the ceiling are part of the ventilating arrangement; they carry off the carbon dust from the burning arc lamps. The three motion picture projector lamp houses are in line to the left; beyond them three other pipes leading up to the ceiling show the location of the three spot light or "effect" machines used with the stage show.

The motors, knobs and switches at the back of each lamp house control the arc light within.

To the left of the first lamp house may be seen a grille-work that covers the shutter

and protects careless fingers. The shutter is a two-bladed fan that cuts off the light whenever the film moves, admitting light again during those instants when the film stands perfectly still while one frame, or picture, is projected on the screen. Then the shutter closes off the light, the film moves, the next frame slips into place and rests motionless, and the shutter again permits light to flow through to the lenses. This cycle of events takes place sixteen times in each second. Just above and to the left of the shutter in Fig. B is the upper magazine from which the film comes; it winds downward through the "projector head" just to the left of and below the shutter, in which the intermittent motion is secured by a system of gears, and winds up again on the lower magazine which can be dimly seen to the right (in front of the drive motor). The lens with which the picture is focussed on the screen is in the tubular body just to the left of the projector head.

One of the complications of sound equipment lies in the fact that the film must move intermittently—stop and start, and stop and start—to project a moving picture, while the disc turntable must move with flawless steadiness. When a photoelectric cell is used, the sound track must move past this cell with the most perfect steadiness. Therefore the gears allow for a loop in the film, which loop expands and contracts to take up the slack between the place where the gears drive the film intermittently and the place where they drive it with a steady motion. The necessity for intermittent motion at one place makes smooth motion at another point difficult to obtain, and is the reason for the elaborate system of vibrating filters used in the flywheel and under the disc turntable.

This system of gearing, the "threading up" of the film, and the photo-cell with its exciting lamp and its "B" batteries are not shown in these illustrations, but will be pictured in a subsequent installment.

A most important part of the installation, not as yet discussed, is shown in Fig. B, just to the left of the second lamp-house exhaust pipe. This is the "film-disc switching cabinet" and the fader. They are two small boxes, mounted on the front wall. All three projectors in this illustration are wired to the film-disc cabinet. This cabinet contains relays. Pushing a button selects between photo-cell pickup and disc reproducer pickup. Signal lamps on the film-disc cabinet show which source of sound current is being used. Just below this cabinet is the fader, which is a combination of volume control and switch. By means of the fader, pick-up from any one of these three projectors is selected to be fed to the main amplifier, and at the same time volume is varied as desired. The fader output runs to the switching panel at the top of the middle rack in Fig. A. By means of this panel either the fader, announcing microphone, or a "non-synchronous" phonograph (not synchronous with the picture) pickup can be connected to the amplifier below it.

The radio reader will perceive that this sound system consists essentially of a five-stage A.F. class A amplifier of high quality and 24 W. output, with several sources of sound supply and switches for selecting any one of them; with several loudspeakers and switching arrangements for matching their impedance; with more than one source of power supply (line voltage, storage batteries, and "B" batteries for the photo-cell); with accurate line voltage control; with a special vacuum tube circuit for controlling the speed of the projector drive motor; with a sufficient number of meters to insure accurate operation at all times; and with many of the more important switches equipped with signal lamps to prevent or to correct possible mistakes in operation.

The apparatus is not all built into one cabinet, but is mounted about the walls in various convenient locations. Storage batteries, supply rectifiers or motor-generators, are commonly placed in another room. Sometimes the amplifier rack is also in another room. The fader is almost always mounted on the front wall, where the projectionist can operate it while watching the screen. When one reel is run out and the next must start he switches the picture from one reel to another by means of a foot-switch, and at the same time switches the sound by means of the fader. Connection boxes and fuse boxes are included in the wiring, including in many

RCA VICTOR

Portable Public Address System

Type PG-62-B

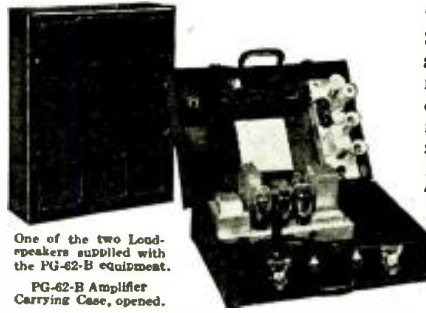

One of the two Loudspeakers supplied with the PG-62-B equipment.

PG-62-B Amplifier Carrying Case, open.



Centralized Sound Section
RCA VICTOR
 Company, Inc., Camden, N. J.
 "RADIO HEADQUARTERS"



Velocity Microphone and Stand



PG-62-B Carrying Case containing Two Loudspeakers and Cables, open

Type PG-62-B complete Portable Public Address System, including the famous *Velocity Microphone*, a high grade Class B 20 watt amplifier and two modern dynamic loudspeakers with extension cords—all self-contained in two convenient carrying cases. Operates on 110 volts AC, and is designed to faithfully reinforce speech and music. Has provision for electrical phonograph input.

Type PG-63 is a less expensive model, employing one loudspeaker and carbon type microphone, and is self-contained in one carrying case.

Write for descriptive folders

Portable electric phonograph units of single and double turntable types available for either of the above equipments.

Only in the Model 5400 Analyzer!!

Free Reference Point System of Analysis Plus Automatic Selection

Why bother memorizing a complicated numbering system? Why waste time plugging connectors into jacks? In the Model 5400 Analyzer all switching is automatic with selector switches. All socket terminals and circuits are clearly etched on panel. This improved method of analysis provides maximum flexibility and also maximum speed and efficiency. Obsolescence is impossible. Where other testers require pages of instruction to explain complicated numbering systems, the Model 5400 analyzer needs no directions whatsoever since all terminals and circuits to be measured are plainly readable.

The complete analysis is made instantly through an analyzer cable and "Sure Pull Out" adapter, without removing the set from its cabinet. The 5400 possesses every other modern and desirable feature. The complete point-to-point analyzer measures resistance between any two points, also current for all necessary circuits. Selector switches are provided for voltage and current readings. Momentary switches protect the meter.

A single meter takes care of all A.C. and D.C. readings. Any scale of volt-ohms-milliamperes is automatically available to all circuits. All scales and ranges are available for external measurements. D'Arsonval—3½" meter. Grid shift switches provide for rapid accurate tests of all tubes. No external batteries required. Due to the use of the Free Reference Point System, Automatic Selection, 9-9 prong socket, 10-wire analyzer cable and switches with additional joints for reserve capacity, the 5400 Analyzer will always be up-to-date even though tube elements undergo complete re-arrangement. Send for FREE DATA SHEETS on Model 5400 Analyzer, Super Test Unit, Multimeter, Dependable Tube Tester and other quality radio servicing instruments.

RADIO CITY PRODUCTS CO. Dept. RC

48 WEST BROADWAY.

NEW YORK, N. Y.

Price complete, including test probes, spring eras, chassis clamp and complete set of adapters. Housed in handsome leatherette carrying case.

\$34.50

Net to dealers and servicemen
 List \$65.00

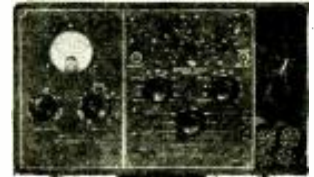

Dependable Analyzer—Model 5400
 Knock Down Kit (less batteries) with Complete Instructions.

\$26.00

net to dealers and servicemen.
 LIST \$49.00

Announcing Amazing Typewriter Bargain

New Remington Portable only 10c a Day

10-DAY FREE TRIAL OFFER

Only 10c a day buys this latest model Remington Portable!

Not a used typewriter. Not a rebuilt machine. It's a brand new, regulation Remington typewriter. Simple to operate, yet does the finest work. Full set of keys with large and small letters.

Try this typewriter in your home or office on our 10-day FREE TRIAL OFFER. If at the end of 10 days you do not agree that this Remington is the finest portable at any price, you can return it at our expense. Don't delay. Don't put it off. Mail the coupon today. Or use postcard if you prefer.

Write for our new catalogue showing the most complete line of portable and desk models ever offered.

FREE TOUCH
 TYPEWRITING COURSE



MAIL
 COUPON

for full facts about
 this astounding offer

REMINGTON RAND INC., Dept. RC-6
 BUFFALO, NEW YORK.

Please tell me how I can buy a new Remington Portable Typewriter for only 10c a day. Also enclose one of your new catalogues.

Name
 Address

SURPLUS RADIO PRODUCTS

ORDER DIRECT FROM THIS ADVERTISEMENT—WE DO NOT ISSUE ANY CATALOG

WE HAVE ON HAND

173 Westinghouse Power Generators

The special generator illustrated is of the self-excited inductor type. The rotor serves two entirely distinct purposes: 1. It carries the inductors or the A.C. generator, which has stationary field and armature coils. 2. It carries the D.C. armature, which corresponds to the exciter in other machines.

Power Generator

MANUFACTURED FOR U. S. GOVERNMENT \$75.00 VALUE

There are two pairs of stator poles—two North and two South. Around these four poles are wound the four field coils which, when energized, produce poles of alternate polarity. Each of these poles is provided with four slots into which are fitted the A.C. windings. The rotor is a 12-tooth inductor that carries the D.C. armature coils which supply the D.C. exciter current required by the alternator; a built-in commutator takes off the generated D.C. Three leads extend through the casing to permit a 4½ V. flashlight-type battery to be switched into circuit for starting, and to control the A.C. output of the generator. Rotated at its normal speed of 3,500 r.m.m., the output is 200 W., at 115 to 125 V. (on open circuit), 900 cycles.

Manufactured by Westinghouse for the U. S. Signal Corps, the sturdy construction of this instrument recommends it to the technician. The rotor turns in ball bearings. Shaft length (driving end), 2 ins.; diameter, 9/16-in.; the end is threaded for a distance of 3/8-in. At the end opposite from the drive shaft extends 3/4-in. Case dimensions, exclusive of the shaft, 4½x6¼ in. in diameter. Guaranteed new and perfect. Worth \$75.00, but while they last, only \$4.95, plus shipping charges. Shipping weight 13 lbs. Send check or money order.



Sale of 217 King-Silvertone POWER PACKS



A replacement unit for the popular King and Silvertone sets. Consists of Power Transformer and Choke for Silvertone 1928 and 1929 Models, and for King Models H and J. Measure 6½ x 5½ x 2¾". Wt., 5 lbs. Supplies 4-226, 1-227, 2-71A and 1-280. Specifications: 1½ V. at 1½ amps.; 2½ V. at 1¾ amps.; 5 V. at ½ amp.; 5 V. at 2 amps.; 600 V. C.T. at 60 mills.

PRICE \$1.73 as long as supply lasts Each

REMIT BY CHECK OR MONEY ORDER FOR FULL AMOUNT OF EACH ITEM—SHIPPED EXPRESS COLLECT. NO C. O. D. ORDER ACCEPTED—MONEY REFUNDED IF NOT SATISFIED.

Wellworth Trading Company 111 West Lake Street, Chicago, Ill. RC-134

Enclosed you will find my remittance of \$ _____, for which please send me:

- () Power Generator, \$4.95 each
- () King-Silvertone Power Pack, \$1.73 each

Name _____

Address _____

City _____ State _____

cases one central connection box in which most of the circuits between apparatus can be found wired to connection blocks.

Sources of Information

If you, the radio reader, were trying to explain radio work to a talking picture sound man, you might take one radio receiver all apart, or at least show pictures of it, and explain what the different parts are. Then you might say: "There are many makes of 'radios,' but they are all fundamentally the same thing; and for individual differences, why, here is a cyclopedia of circuits, and here a bunch of bulletins of manufacturer's data." A sound man trying to explain sound apparatus to radio technicians can only say: "Well, here's one sound system. It's pretty complete—unusually complete—chosen as one that contains nearly everything that may be found in almost any projection room, and more than you'll find in most. Most of the others don't have double emergency amplifiers, or some of the other complications of this one. Now for individual differences. . . ." There is no such thing as a cyclopedia of sound equipment containing all the circuits of all manufacturers. But every piece of apparatus shown in these two pictures has a blue-print of its wiring pasted up inside its front or back cover. That is the general rule in all sound equipment. Wiring between apparatus is sometimes drawn inside the common connection box. Sometimes the wires are tagged. Sometimes circuits between one piece of apparatus and another have to be "trung" (or "buzzed") out.

Shooting Trouble

The size of the equipment does not make trouble shooting more difficult—it makes it easier. The trouble must be in one place—some one piece of equipment. The first thing to do is to find which panel is at fault. The meters and signal lamps that are so plentifully used are an enormous help in this, and once the guilty panel is found trouble is run down inside it in just the same way that trouble is run down inside a radio receiver—by ordinary electrical rules that every radio Service Man knows. Meanwhile, an emergency exists, and if there is any way to rig up a haywire arrangement that can put the show back temporarily, that is the first thing to do, for the show must go on. It is especially in devising such emergency arrangements—once he has become familiar with the equipment—that the training and resources of the radio man enable him to render enormous and most valuable help. But more will be said of this later.

Details of the equipment will be given further attention in future articles, but one word of advice that may not be out of order here, is this: If you are a competent radio Service Man, able to fix any ordinary trouble in any ordinary "radio," and to use common sense, don't be scared by the mere brute bulk of this stuff. Parts are heavier and sturdier, equipment is scattered about more—very much as if in an ordinary superheterodyne receiver the I.F. were in one box, the oscillator in another, the first-detector in another, and the second-detector and audio in others—loud-speaker and rectifier and filter pack all in boxes of their own, all wired together along a wall. Superheterodynes once were built that way, and sound equipment is going through the same evolution as radio, becoming more compact. But essentially—electrically—the apparatus shown in Figs. A and B is not a bit more difficult to get along with than any high-quality "radio"—in some ways—in the help given by meter and signal lamps, for example—much easier. And it is precisely the scattered arrangement that provides your best opportunity to sell the theatre auxiliary parts. For one example, many theatres still don't have those line voltage controls, but need them.

THE ABS QUIT

Ed. Wynn's long-awaited broadcast chain which recently started operations with headquarters in New York, lasted exactly 3 days—after which its world-famous president offered his resignation; and now it is bankrupt!

The stations connected with this would-be chain are continuing to broadcast individually.

SERVICE ELECTRIC Refrigerators!

In your community there are dozens of electric refrigerators to be serviced. Many need immediate repairs which can be made quickly, with little expense—and which you can repair with the aid of this authoritative Refrigeration Service Manual. Make many extra dollars, together with other repair work. Electric refrigeration servicing is a well-paying business—start in your spare time—before long you will devote full time to it. One or two jobs pays the small cost of the OFFICIAL REFRIGERATION SERVICE MANUAL.

96 Pages of New Data Have Been Added to the OFFICIAL REFRIGERATION SERVICE MANUAL

To bring this useful service manual right up-to-date, Mr. L. K. Wright, the editor of the OFFICIAL REFRIGERATION SERVICE MANUAL, has aided a wealth of material on new electric refrigerators, and older models as well. As usual every refrigerator has been accurately described from the viewpoint of servicing—diagrams to illustrate the essential parts, so simplified that repairs can easily be made. The addition of these new pages will not increase the cost of the book to those who order their copy now.

Here Are Some of The Important Chapters:

- Introduction to the Refrigeration Servicing Business
- History of Refrigeration
- Fundamentals of Refrigeration
- Description of All Known Types of Refrigeration Motors
- Trouble Shooting
- Unit Parts, Valves and Automatic Equipment
- Makes and Specifications of Units
- Manufacturers of Cabinets
- Refrigerants and Automatic Equipment and Many Other Important Chapters



Over 1,200 Diagrams
450 Pages
Flexible Looseleaf Binder
Complete Service Data

Mail Coupon Today!

GERNSBACK PUBLICATIONS, Inc. RC-134
96-98 Park Place, New York, N. Y.

I enclose herewith my remittance for \$5.00 (check, stamps or Money Order accepted) for which you are to send me, postage prepaid, one copy of the OFFICIAL REFRIGERATION SERVICE MANUAL, together with the extra 96 pages of new material at no extra cost.

Name _____

Address _____

City _____ State _____

Here's a book every Radio Man will refer to dozens of times every day—



A Valuable RADIO BOOK!

HERE is one radio book that answers every conceivable question on interference. It contains 76 pages, 8½x11 inches, chock full with wiring diagrams, drawings and photographs showing where interference originates—how it is distributed, and how to eliminate it. This is a wealth of information needed by every radio listener, dealer and Service Man.

Send fifty cents in stamps or check for this book.

RADIO-CRAFT MAGAZINE
96-98 Park Place New York, N. Y.

MAILING LISTS

Pave the way to more sales with actual names and addresses of Live prospects. Get them from the original compilers of basic list information—up to date—accurate—guaranteed.

Tell us about your business. We'll help you find the prospects. No obligation for consultation service.



FREE 60 page Reference Book and Mailing LIST CATALOG

Gives counts and prices on 8,000 lines of business. Shows you how to get special lists by territories and line of business. Auto lists of all kinds. Shows you how to use the mails to sell your products and services. Write today.

R. L. POLK & CO.
Polk Bldg.—Detroit, Mich.

Branches in Principal Cities
World's Largest City Directory Publishers
Mailing List Compilers. Business Statistics. Producers of Direct Mail Advertising.

HOW

COMPLETE IS YOUR RADIO SERVICING FILE?

Every Service Man and Dealer must, without any question, have his servicing material right up-to-the-minute, and most assuredly, it must be complete in every respect. In the CONSOLIDATED OFFICIAL RADIO SERVICE MANUAL, the only complete One-Volume book on radio servicing, will be found over 2,300 pages, over 5,500 diagrams, charts and photos. Full details will be found on page 442.

SUPER P.A. SYSTEM

(Continued from page 400)

down as low as 8 cycles per second!

The single-stage pre-amplifier unit which was located between the microphone and the mixer circuits is shown in Fig. 2. This amplifier contains a single tube and is coupled at the input and output by transformers. The amplification in this single-stage pre-amplifier is approximately 24 db. The input is fed from the microphones through a 30 ohm impedance line to the primary of the input transformer. The output of the pre-amplifier is adjusted to 200 ohms which matches the mixer impedance.

From there the signals are fed into the 2-stage pre-amplifier, Fig. 3, which is also transformer coupled at input and output. This amplifier has an approximate gain of 39 db. Both the input and output impedance of the coupling transformers are adjusted to 200 ohms and the output is fed to the master gain control where the volume of the entire system is adjusted to the instantaneous level required.

The Voltage Amplifier

The voltage amplifier follows the gain control and in this amplifier will be found several unique features. In the first place, it is a double-resistance-coupled amplifier, similar in appearance to resistance-coupled push-pull amplifiers. Each stage contains two tubes working exactly 180 degrees out of phase.

The output of the second stage of this amplifier is divided into three distinct sections illustrated in block form in Fig. 1 (shown in Part I). Each of these three sections covers one part of the audible frequency spectrum; that is, the bass register, middle register, and high-frequency register. Each of these sections contains a voltage amplifier of the "double resistance" type mentioned above, and a power amplifier feeding into the speaker units.

To select the frequency response desired, the capacity of condensers C23 and C24 shown in Fig. 4 are varied. For the high frequencies, small condensers are used for this coupling; for the middle register, larger capacities are used; and, for the bass frequencies, a combination of condensers and A.F. chokes is used. This combination of capacity and inductance represents a band filter with a cut-off above 200 cycles. The circuit diagram of the power amplifier units is shown in Fig. 5. The size of the tubes used in this stage depends upon the output required. For the bass register, this output is approximately 46 W. for each amplifier; for the middle register about 12W.; and, for the high frequencies, 5½ W. These output ratings allow only 1% second-harmonic content, and will, of course, be increased about 1/3, if the usual 5% harmonic distortion is permitted. The gain in the voltage and power amplifiers is about 76 db., maximum.

The frequency response of the entire P.A. system is shown in the graph in Fig. 6. This chart shows the output of the low-frequency, middle-frequency, and high-frequency units, as well as the frequency characteristic of the complete system.

In Figs. G and H, respectively, are shown the amplifier and rectifier panels. (In this installation there are two distinct amplifiers which may be operated either individually or in unison.)

The above general description will give an idea of some of the difficulties which may be countered in designing P.A. systems for large auditoriums, where true fidelity of reproduction is a necessity. We have not mentioned anything about the balancing of the individual amplifiers; impedance adjusting; acoustic feedback, or any of the other difficulties which the installation engineer invariably encounters. However, any Service Man who has attempted to install a P.A. system is familiar, at least in part, with these difficulties.

(Courtesy is extended to Mr. T. F. Bludworth, President, and W. C. Blaisell, Chief Engineer, Bludworth, Inc., who gave the writer every possible assistance in the preparation of this article. Note that all available data appears in the article and accompanying illustrations.—Author)



"Can I take it!"

Lefts and rights in the shape of heat, vibration, excess voltage . . . mean nothing to a Centralab Fixed Resistor. . .

Baked at 2700 degrees it takes every abuse "on the chin" and comes up smiling.

That's why we say . . . insist on Centralabs.

Centralab
CENTRAL RADIO LABORATORIES
MILWAUKEE WISCONSIN

PRACTICAL RADIO ENGINEERING

An opportunity for RADIO MEN to enlarge their scope of training.

Whether elementary radio principles or advanced subjects, sound applications or practical radio engineering, RCA Institutes is prepared to give you the instruction you need.

RESIDENT SCHOOLS NEW YORK AND CHICAGO with modern standard equipment
EXTENSION COURSES FOR HOME STUDY under convenient "no obligation" plan.
Illustrated Catalog on Request

RCA INSTITUTES, INC.
Dept. RT-1

75 Varick Street, New York
1154 Merchandise Mart, Chicago

Improve

—your radio construction work by following the technical data in the new Hammarlund Catalog.

For FREE COPY, write Dept. RC-1. Ask also for information on COMET "PRO"—Superheterodyne with Crystal Filter and Automatic Volume Control.

HAMMARLUND MFG. CO.
424 W. 33rd Street
New York, N. Y.

For Better Radio
Hammarlund
PRECISION PRODUCTS

FREE!

Choice of One or More of These Popular Short Wave Books

Here's money put right into your pocket—here's a saving you never gave a thought to. You get absolutely FREE any one or more of the regular 25c and 50c short wave books with a year's subscription to SHORT WAVE CRAFT, the Radio Experimenter's Magazine. A one year's subscription brings you one fifty cent book or two twenty-five cent books; a two-year subscription brings you two fifty cent books and any one twenty-five cent book. Decide NOW what books are most necessary to you—then send us your subscription by return mail. The books will be sent to you immediately.

25¢ The Copy



On All Newsstands

4-Color Cover
9" x 12" in Size
Over 200 Illustrations



No. 1 50c
No. 2 50c
No. 3 25c
No. 4 25c

THIS popular short-wave magazine interests the great army of "hams," broadcast listeners, and general radio students who are interested in experimental as well as scientific angles of short wave development and application. In each monthly issue appears the largest and most correct short-wave station call list, and important construction articles on receivers and transmitters, including "picturized" diagrams easily understood by anyone, a big feature "originated" by SHORT WAVE CRAFT. You'll also find the latest news about short-wave physics, micro- and ultra-short waves and other applications of this newest branch of radio.

Many Short Wave Sets to Build

Many excellent short-wave sets with complete construction details with "picturized" diagrams, are found in every issue—these sets vary from simple one- and two-tube sets to those of more advanced design, five and eight tubes.

Big Silver Trophy FREE!

Recently inaugurated by Mr. Hugo Gernsback, Editor, was the "Short Wave Scout Contest." To the Short-Wave "fan" who has logged and obtained verification of the largest number of short-wave stations from all over the world, during one month, will be awarded a magnificent silver Short Wave Scout Trophy.

Mail This Coupon Today!

SHORT WAVE CRAFT, Dept. RC-134
96-98 Park Place, New York, N. Y.
Gentlemen: Enclosed you will find my remittance for a subscription to SHORT WAVE CRAFT for
[] One Year @ \$2.50 (Canadian and foreign \$3.00)
[] Two Years @ \$5.00 (Canadian and foreign \$6.00)
Send me FREE books which are circled below.
1 2 3 4

Name
Address
City State

READERS' DEPARTMENT

(Continued from page 403)

Now it is going to be tough waiting for the balance of Mr. Nadell's series, but while we wait allow me to mention the articles which I like best in RADIO-CRAFT.

First: new simple test equipment, such as point to point systems (lets have more on this).

Second: Service Data sheets; never miss one of these.

Third: Operating Notes.

Fourth: Readers' Department; very good. I would like to see a service department conducted by Frank L. Sprayberry; an auto-radio service department; and a department devoted to servicing theater equipment (of course this is what I would like to see). I wonder how many more agree with me or disagree?

In conclusion, how about an article on a tube tester utilizing an oscillator and an output meter; one that won't go stale on us for a while at least?

S. M. LOCKWOOD,
4225 N. Paulina St.,
Chicago, Ill.

THE "PHANTOM" DEFECT

Editor, RADIO-CRAFT:

I note the question submitted by Mr. Paul V. Brown in the June issue of RADIO-CRAFT: I had a similar problem over a year ago. My set, a Philco model 70 A.C. set, acted similar to Mr. Brown's. This receiver was sent to the state distributors on two different occasions (about 6 months apart). The receiver was returned as O. K. each time, but after operating it for a few days it did the same thing, first fading and then blocking, and by snapping the switch off and on again it worked O. K. for a while. It did this for about 9 months. In all this time I had tested the receiver a dozen times for every possible defect.

One day I took it out, turned it upside down and set it going, and taking a neon lamp tester went over the set completely as I had done several times. However, this time when it faded I happened to touch one of the balancing units and, presto, it came back to normal operation. In this model the balancing condenser and also a small fixed condenser are in one unit. I resoldered all the connections but it did not remedy the matter, replacing the unit cured the trouble and the receiver worked O. K. All tests showed this unit O. K. when cold but went wrong after it got warmed up. I thought at first it was a loose connection but it was not; it was in the balancing condenser. I trust this will help you.

H. J. PRESHINGER,
Radio Electric Shop,
Geraldine, Mont.

P.A. IN A FARMING TOWN

Editor, RADIO-CRAFT:

The following account of how we made use of a P.A. system may be of interest.

To understand the purpose of this system's use here one should understand something about our town. Lenox is a small village of 1,200 population in a community entirely agricultural. Naturally, a town of this size does not boast of a large business section! Lenox does most of its business on one block, plus one-half block each way from one end of the main block. The farmers drive in for most of their buying on Wednesday and Saturday nights. Usually, more business is done from 7 to 11:30 P.M. on Saturday night than during all the other days of the week combined!

The object of the P.A. system was to furnish entertainment and to stimulate business.

Two of us, with only a slight knowledge of the workings of a P.A. system, borrowed the money and started out. We purchased an amplifier, two dynamic speakers, mike, turntable, pickup and control box. We started last year, in September, and worked every Wednesday and Saturday night until October 17th. This Spring we had our opening program on May 7th and discontinued on October 15th. We have had lots of fun, given en-

Increase YOUR SERVICING BUSINESS 25%

If you are overlooking servicing auto radios, then you're missing a great deal of business. The auto-radio business had its greatest boom this past summer and thousands of sets were sold. By this time many of these same sets require servicing and with hundreds of them right in your own community, you can build up a good auto-radio servicing business. In a short time you can easily add 25% or more to your regular servicing business.

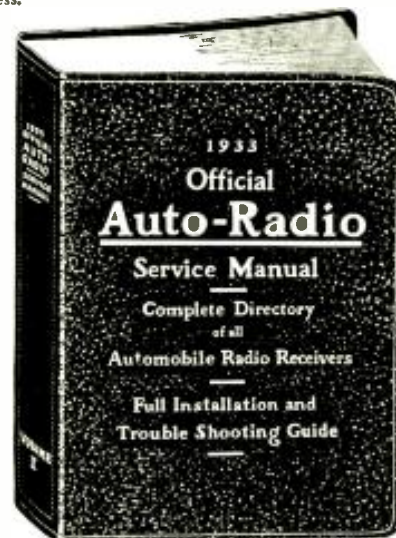

\$2.50 A Copy

Every man connected in any way with the booming auto-radio business will want a copy of this book immediately. It is devoted exclusively to auto-radio service "done" in complete, understandable form. The OFFICIAL AUTO-RADIO SERVICE MANUAL contains schematic diagrams, chassis layouts, mounting instructions, and trouble shooting hints on all 1933 and many older model auto-radio receivers. This Manual contains a "goldmine" of information.

List of Sets Covered in the Manual

- | | |
|---------------------------|----------------------------|
| Atwater Kent Mfg. Co. | Chas. Hoodwin Company |
| Autocrat Radio Company | Montgomery Ward & Co. |
| Cartier Genemotor Corp. | National Co., Inc. |
| Chevrolet Motor Company | Philco Radio & Tel. Corp. |
| Crosley Radio Corp. | Pierce-Airo, Inc. |
| Delco Appliance Corp. | Premier Electric Co. |
| Emerson Electric Mfg. Co. | ROY-Victor Co., Inc. |
| Federated Purchaser, Inc. | Sentinel Radio Corp. |
| Fada Radio & Elec. Corp. | Sparks-Wilmington Corp. |
| Ford-Majestic | Stewart Radio & Tel. Corp. |
| Franklin Radio Corp. | United Amer. Busch Corp. |
| Galvin Mfg. Corp. | United Motors Service |
| General Electric Co. | U. S. Radio & Tel. Corp. |
| General Motors Corp. | Wells-Cardner Company |
| Grigsby-Grunow Co. | Zenith Radio Corp. |

Over 200 Pages
Over 500 Illustrations
9x12 Inches
Flexible, Loose-Leaf Cover

Mail This Coupon Today!

GERNSBACK PUBLICATIONS, Inc. RC-134
96-98 Park Place, New York, N. Y.

Enclosed you will find my remittance of \$2.50 for which please send me one copy of the 1933 OFFICIAL AUTO-RADIO SERVICE MANUAL. (Send remittance in check or money order. Register letter if it contains cash or currency. WE PAY POSTAGE.)

Name
Address
City State

tainment to many people, boosted for our town, and paid for the outfit.

This year we extended our outfit so as to give complete coverage on the main business block with less output and better quality. Our "studio" was in the front end of a restaurant where people on the street could look in and see as well as hear. (The street would often be crowded so that autos would be unable to get through.)

We had the usual grief with packed buttons and broken down filter condensers, but enjoyed it all. Two days following our first "broadcast" last year, we amplified Governor Turner's talk at a small town "Home Coming Festival" and got away with it amazingly well. We found out later that only one button of the mike had been properly hooked!

This year we have used six small magnetic units and two dynamic cone speakers, in second-story windows; and on the roofs of one-story buildings.

Last winter we tried out dances using recordings. These dances were not a success as the dancers seem to want an orchestra in sight—I do not understand the psychology of it.

Just before primary elections last June we had several of the county candidates give five-minute talks. Due to the depression we did not try for any engagements outside of town.

Our charge to the merchants for their ads. was held to a minimum as we did not go into it as a money-making proposition. However, it could be made to pay good money if properly handled. Anyone who can sell advertisements to small town merchants twice each week during this depression (and most of the time write the ads, as well) should be able to sell anything to anyone.

Any further information desired about the workings of a P.A. system in a rural community will be gladly given on request.

D. L. BARE,
Lenox, Iowa.

THE MODERN BLOOPER

Editor, RADIO-CRAFT:

I have a problem that I would like you to think about. Some of the cheap sets that are being put out now set up interference in other receivers. A case has been brought to my attention, of an apartment house where there are two of the Majestic model 310A sets and due to the fact that they have an unshielded oscillator coil, they broadcast a signal 175 kc. below the station tuned in, and thus bother all other radio receivers in the vicinity. The owners have spent good money for these sets and don't care to junk them, but the neighbors are also entitled to good reception.

I have tried shielding the chassis and have written to the manufacturer without result. Must I conclude that there is no solution to this problem? I have noticed the same condition in sets of other manufacturers, the manufacturer mentioned above is not the only offender!

I wish that you would publish this letter to "raze" the manufacturers for putting out such sets in this day of congested conditions.

G. W. LAWRENCE,
Norton, Kansas.

(This condition is indeed deplorable. With the sensitive sets of today, "bloopers" are unforgivable. And the worst of the situation is that there is no practical solution to the problem. As long as manufacturers continue to make such sets, the condition will remain.

To cure an individual case, the oscillator coil can be shielded and a filter inserted between the set and the power supply lines; or a single stage of untuned R.F. connected as a "blocking" circuit. After the set has been realigned, radiation is usually eliminated or reduced a great deal.

However, it is virtually impossible to do this to every radio set that "bloops," even if the owners were willing to pay to have the changes made.—Associate Editor)

"FOUR NEW AMPLIFIERS"—PRO AND CON

Editor, RADIO-CRAFT:

I am sending a verbal "scallion" to Mr. F. Lester who wrote the article, "Four New Amplifiers" in the October, 1933 issue. This

article stated that they get 28 W. undistorted output—uncanny, what these new amplifiers will do!

According to the distortion curve in ELECTRONICS magazine, the per cent of distortion rises sharply when the power is increased over 10 W. and they also state that the tubes, (59's in class B) are capable of 20 W. undistorted output, so I would like to be let in on the secret of how they get the 28 W.—maybe its due to the 3.2 per cent they use!

GIBSON BRINDLEY,
Radio Service Shop,
1101½ Hamilton Ave.,
Trenton, N. J.

EDITOR, RADIO-CRAFT:

We wish to acknowledge the letter of Mr. Gibson Brindley.

The writer is sure that if Mr. Brindley will once again refer to the curves that he mentions, he will find that the type 59 tubes in class B are capable of higher than 20 W. undistorted output, depending entirely upon the "driver" of these tubes! The secret of how we get 28 W. is due solely to the form of driver we employ, as well as good quality input and output transformers.

Under actual measurement, the 28 W. class B amplifier saturates at 38-and-a-fraction watts output, this being measured across the 500 ohm line output circuit of the amplifier. We are sure, therefore, that it is agreed, with us, that in rating our amplifier at 28 W. output, we are being very conservative. The distortion percentage is below 10 per cent at 28 W. output which is exceptionally good for class B amplification. This 10 per cent is not noticeable to the average ear.

F. LESTER,
Wholesale Radio Service Co.,
New York, N. Y.

NEON-TYPE CHECKER

(Continued from page 413)

Line voltage regulation is provided by a variable resistor in the A.C. line. By a single-pole single-throw push button switch, the neon tube is hooked across the 230 V. winding. Placing the "English reading" shunt resistor at point No. 12, which is approximately 10,000 ohms resistance, changes the characteristics of the neon tube in such a manner as to permit it to be adjusted to a point on the scale indicated by a red line (about in the center of the "Good" section). When the neon beam is adjusted to this line the voltage on the primary is approximately 100 V.

Instructions

Set Sw.3 (knob No. 1) on the off position. Insert the tube in the socket indicated on Table I. Set knob No. 1 to position 1, 2, 3 or 4, as shown. *Caution:* Be sure to have the correct setting to avoid applying the wrong voltage to the filament.

The No. 1 switch at the side left of the panel should be set at position 1 or 2 according to the chart. The toggle switch Sw.2 at the right of the panel should be thrown to "Control Grid" for all tubes with a grid cap on top—all others, to "regular Grid." Set knob No. 2 (R1) at 12, press the red button, adjust the line voltage control (located in upper right hand corner of the cabinet) turn right or left until the neon light column is even with the red line. Set control knob No. 2 according to the chart. Press button Sw.5 "Press to Read"; if the tube is good, the light will rise to the "Good" section. If the tube is burned out, or weak, the light will show, or rise only to the "Renew" Section of the scale.

Shorted tubes will cause the indicator tube to burn very bright, and light will spill over the top of the anode.

To test for a short between cathode and filament, press button "Press to Read" and the white button at the same time. If the neon light beam doesn't disappear, the tube is shorted. This applies only to heater type tubes.

To test one plate of a full-wave rectifier, test in the usual way. To test second plate, press button "Press to Read" and button No. 80 (Sw.7) at the same time.

Get Your Copies of the SHURE TECHNICAL BULLETIN

Because of the widespread interest in the SHURE TECHNICAL BULLETIN and the numerous requests for back issues . . . the following back issues are available now at

6c per copy.

- No. 1** Condenser vs. Two-Button Microphones.
- No. 2** Field Problems in Microphone Placement. Part 1—Broadcasting.
- No. 3** Field Problems in Microphone Placement. Part 2—Public Address Systems.
- No. 4** Mixing Circuit Design Data.
- No. 5** The Microphone—An Electric Ear. Noise Measurements—Binaural Transmission.
- No. 6** Field Problems in Microphone Placement. Part 3—Multiple Microphone Systems.

The SHURE TECHNICAL BULLETIN . . . a monthly publication of the Shure Brothers Company, 215 W. Huron St., Chicago, microphone makers . . . contains AUTHORITY AND USEFUL INFORMATION on microphones, microphone placement, design data on associated speech-input circuits, new applications of microphones for industrial and research purposes, and similar technical phases of broadcast and sound engineering.

Copies of the SHURE TECHNICAL BULLETIN may be had without charge by broadcasting, public-address and recording engineers simply by sending in your request on your company's letterhead.

Subscriptions accepted from amateurs, radio service men, and others at the nominal fee of 50c per year.

To be sure of having these valuable issues send for them now. Use the coupon below.

SHURE BROTHERS COMPANY
215 W. Huron Street, Chicago, Ill.

Please send me postpaid the following back issues of the SHURE TECHNICAL BULLETIN:

_____ No. 1 _____ No. 4
_____ No. 2 _____ No. 5
_____ No. 3 _____ No. 6

I am enclosing _____ c
(in stamps) (in cash).

Please enter my subscription for one year. I am enclosing 50c in stamps in cash in money order.

Name _____

Address _____

City and State _____

RC134

Classified Advertisements

Advertisements in this section are inserted at the cost of twelve cents per word for each insertion—name, initials and address each count as one word. Cash should accompany all classified advertisements unless placed by a recognized advertising agency. No less than ten words are accepted. Advertising for the February 1934 issue should be received not later than December 9th.

CABINETS WANTED

RCA-106 Cabinets—less speakers. Will pay cash. Write Reese Electric Company, North Syracuse, New York.

MUSICAL

PLAY Piano by ear. Complete course \$3.00. Formerly \$15.00. Joe Boucher, Box 12-15, Ottawa, Canada.

POWER SUPPLIES

(Formerly \$15.00). Joe Boucher, Box 12-15, A.C. POWER, less than \$5.00. Build a 300-watt, 110-volt, 60-cycle, public address or light generator. Complete plans \$1.00. A.C. Power, P. O. Box 382, Vincennes, Indiana.

RADIO

RADIO PARTS—WE CARRY EVERYTHING for receiving and transmitting. Wedel Company, Inc., Wholesale, Seattle, Washington.

SONGWRITERS

SONGWRITERS! Poems, melodies. Amazing opportunity. Hibbeler, D153, 2104 Keystone Chicago.

\$1 PAYS FOR 3000 LIFE PROTECTION

Even If You Are Past 55

The National Security Assn., 204 S. Hamilton Dr., Dept. 76-W, Beverly Hills, Calif., is offering to men, women and children, between the ages of 10 and 75, a new Life Protection Membership Certificate without medical examination for \$1, which pays \$1000 for death from any cause; \$2000 to \$3000 for accidental death. SEND NO MONEY. Just your name, age, name of beneficiary, and a Life Certificate, fully made out in your name, will be sent to you for 10 Day's Free Inspection. NO AGENT WILL CALL. If you decide to keep it, send only \$1 to put your protection in force for about 45 days—then about 3c a day. If not, you owe nothing. OFFER LIMITED. So write today.

SEXOLOGY

THE MAGAZINE OF SEX SCIENCE

SEXOLOGY, foremost educational sex magazine, is written in simple language and can be read by every member of the family. It is instructive, enlightening—not a risqué book—contains no jargon. Devoted to Science of Health Hygiene.

Contains 25 important articles on Sex Science, 68 pages, with attractive two-color cover. Here are a few of the more important articles: The Male Reproductive Organs (Illustrated); The Cycle of Menstruation (Illustrated); Three Unusual Types of Pregnancy (Illustrated); Napoleon's Sexual Transformation; Bed-Wetting and Sex Weakness; Sex-Life During Pregnancy; Is Sexual Abstinence Harmful?—A Reply; Can We Control Sex of Offspring?; Masturbation—The Truth About It; Are Douche Necessary?; A Man Becomes a Woman.

Get a copy of SEXOLOGY on any newsstand, or, if your dealer cannot supply you, send 25c in stamps for a copy of the current issue.

SEXOLOGY 25R West Broadway New York, N. Y.

ONE CENT A DAY PAYS UP TO \$100 A MONTH

The Postal Life & Casualty Insurance Co., 102 Postal Life Building, Kansas City, Mo., is offering a new accident policy that pays up to \$100 a month for 24 months for disability and \$1,000.00 for deaths—costs 1c a day—\$3.65 a year. Covers all accidents including those of occupation. Men, women and children eligible. Send no money. Simply send name, address, age, beneficiary's name and relationship and they will send this policy on 10 days' FREE inspection. No examination is required. This offer is limited, so write the company today.

(Six possible settings for R1 (knob 2) are shown in Fig. 1—actually, R1 is continuously variable.)

List of Parts

Two NaAld 4 prong sockets, S1, S2;
One NaAld 5 prong socket, S3;
Three NaAld 6 prong sockets, S4, S5, S6;
One NaAld 7 prong socket (large), S7;
One NaAld 7 prong socket (small), S8;
One Clarostat wire-wound variable resistor, 15,000 ohms, R1;
One Clarostat wire-wound variable resistor, 2,000 ohms, R5;
One Clarostat wire-wound variable resistor, 5,000 ohms, R3;
One Electrad wire-wound fixed resistor, 1,500 ohms, R2;
One Electrad wire-wound fixed resistor, 3,000 ohms, R4;
Two Hart & Hegeman switches, double-pole double-throw, Sw1, Sw2;
One Carter switch, 6-position, Sw3;
One Hart & Hegeman switch, single-pole single-throw, Sw6;
One Acme switch, push-button type, Sw4;
One Acme switch, push-button type, Sw5;
One Acme switch, push-button type, Sw7;
One power transformer, primary 110 V., secondary 230 V., filament 25 V., tapped at 1.5, 2.5, 6, and 12 V.;
One Acme panel;
One Acme glow discharge neon tube;
One Yaxley tip-jack.

TABLE I

Type No.	Soc. ket	K.	K.	Sw.	Type No.	Soc. ket	K.	K.	Sw.
		1	2	1			1	2	1
1	1	3	5	2	42	5	3	10	2
KR1	1	3	5	2	43	5	4	8	2
2A3	1	2	5	2	44	3	3	14	2
2A5	5	2	5	2	45	1	2	8	2
2A7	7	2	14	2	46	3	2	5	1
2B7	7	2	15	2	47	3	2	10	1
5Z3	2	3	9	2	48	5	4	5	2
6A7	7	3	14	2	49	3	1	8	1
6B7	7	3	15	2	50	1	3	14	2
6C6	6	3	11	2	52	3	3	12	2
6D6	6	3	11	2	51	3	2	17	2
6E7	7	3	11	2	55	4	2	12	2
6E7	7	3	11	2	56	3	2	18	2
6L1	1	3	18	2	57	6	2	11	2
10A	1	3	18	2	58	6	2	11	2
12	1	3	11	2	59	8	2	8	2
12A	1	3	11	2	69	4	3	20	2
15	3	1	20	2	70	4	3	20	2
19	4	1	14	1	71	1	3	8	2
20	1	2	12	2	75	4	3	20	2
KR20	4	2	20	2	77	6	3	11	2
22	1	2	20	2	78	6	3	11	2
KR22	4	3	20	2	79	4	3	9	1
24	3	2	15	2	80	2	3	11	2
24A	3	2	15	2	81	2	3	11	2
25	5	2	14	2	82	2	3	9	2
25Z5	4	4	5	1	83	2	3	10	2
28	1	1	18	2	84	3	3	5	1
27	3	2	18	2	85	4	3	12	2
29	4	2	14	2	89	6	3	8	2
30	1	1	19	2	PZ	3	2	10	1
31	1	1	10	2	LA	3	3	5	1
32	1	1	18	2	PZH	5	2	5	1
33	3	1	14	1	Wund.	3	2	20	2
34	1	1	16	2	Wund. A	4	2	20	2
35	3	2	17	2	Wund.	4	3	20	2
36	3	3	14	2	482A	1	3	5	2
37	3	3	12	2	482B	1	3	5	2
38	3	3	11	2	483	1	3	5	2
39	3	3	14	2	484A	3	2	10	2
40	1	3	18	2	485	3	2	5	2
41	5	3	8	2	486	3	2	10	2

OPERATING NOTES

(Continued from page 416)

This damper is made of sponge rubber 1/8-in. thick, and is 3/8 x 9/16-in. long.

Low volume on phono. can also be traced to a poor contact in a radio-phonograph switch. On the same model the filter block breaks down. If the customer wants a cheap repair or has been given a lower estimate, and you want to cut your own, disconnect the lead from terminal three on the filter block and put this lead on the positive side of a 2 mf. electrolytic condenser. The negative lead of the electrolytic condenser goes to terminal 4 on the filter block. A temporary repair can be affected by just disconnecting this lead from terminal 3, and taping the end; the receiver will then function with but a slight increase in the hum.

PHILCO SETS

A COMMON trouble in the Philco 111 and 111A models is an open circuit in the oscillator coil due to the heat expanding the coil form which breaks the wire. In the higher serial numbers this coil was changed to a honeycomb wound arrangement which eliminated this fault. A word of warning may also be said about the range control. If the particular set sounds exceptionally noisy, switch the range control to a minimum position. (This control is located in the back of the two type 45 sockets—looking from the rear.)

Philco 47—if either the 44 or 36 tubes short from filament to cathode the result will be fading and intermittent reception. Also, the pilot light will burn with reduced brilliancy.

MAJESTIC MODEL 52

WHEN you see the complaint, "Majestic 52—doesn't work!" on one of your calls, check the second-detector plate voltage. If there just isn't any, you can be sure it is the 25,000 ohm resistor enclosed in the can holding the sockets of the two 45's and the 80. This resistor is accessible by removing one screw and taking off the back plate. Another common failure in this model is the .1-meg. grid resistor in the oscillator circuit. (This resistor is directly at the oscillator socket.)

BRUNSWICK SETS

IF a Brunswick model 14 or 21 has a rather high hum level, a few changes in the wiring can greatly reduce it. The purple, .1-meg. grid resistor located in the power unit directly above the 27 tube must be changed to a .25-meg. resistor. The bypass for the detector screen-grid should be changed from .1-mf. to .5-mf. (This condenser is located along the side of the detector socket and is tubular in shape.)

Brunswick models 14, 21, and 31, both A.C. and D.C., (the D.C. circuit is shown in Fig. 2.) have a fault which was mentioned in a previous article, namely, the burning out of the primary of the push-pull input transformer. The Service Man's cost on an original replacement is \$3.25. Add to this your labor charge and you have a fancy charge. After losing a few jobs, a scheme was doped out whereby the estimate can be lower and the profit greater. The total cost is now 36c. (See Fig. 3.) Resistors R1 and R2 are placed across the now defunct primary. In this way we get the voltage to the plate of the preceding tube. R2 is only to impress a signal voltage on the remaining output tube or tubes through C2. The values of this set-up are R1 and R2, 25,000 ohms; C1 and C2, .02 to .1-mf.

In the Brunswick models 15 and 22, the most common complaint is oscillation. This is due to open R.F. bypass condensers, which are located between the tube sockets. The casings are of black bakelite; to check, move the connecting lugs on each condenser in turn; if there is a click, and the oscillation ceases, you have found the faulty one. In this same model we have found a weak signal, accompanied by distortion, to be due to an open coupling condenser between the detector and first A.F. This condenser is located under the bakelite sub-panel at the right hand corner of the set.

The Brunswick models 15 and 22 D.C. will motorboat if the 4 1/2 V. "C" battery is at all weak. (The voltage of the 22 1/2 V. battery is not at all critical.) This is the model using the types 71A, 50 and 32 tubes.

A. K. MODEL 61

THE Atwater Kent model 61 gets very noisy after about 2,000 hours of service. This is due to the three filament resistors overheating and, burning away the insulating material between the wire and the iron strip on which they are wound, causing a short. If the center strip burns out, the first two 22 type tubes will not light.

A slipping dial is caused by the rubber friction drive being worn out. For a temporary repair, take out the screw on the dial knob and tear a strip, about 1/8-in. wide from a length of tape and wind the strip tightly around the grooved portion of the rubber.

RCA VICTOR

ON the RCA Superette RT, no reception or intermittent reception is usually due to poor contact on the rotor contact strips of the condenser.

H. WEHLER,
514 E. 138th St.,
New York, N. Y.

MAJESTIC SETS

IN MAJESTIC model 70 the Service Man will often find that the first A.F. tube (a type 26) is getting no plate voltage. It is usual to suspect the primary of the input transformer. However, most of the time we find the trouble is due to an open 1,400 ohm resistor, mounted back of the sub-panel inside the set.

It is very easy to make a repair here without removing the chassis at all, and it is a good idea to try the following trick first.

Remove the hum-control knob and place a Majestic 1,400 ohm resistor from the hum-control shaft to the chassis frame (ground), as shown in Fig. 4. If music comes in O.K., ream out one end of the resistor to fit the shaft, place it on shaft, and place the other end of resistor between the back of the chassis and the bottom of the chassis. A good tight fit can be had by striking the flange of the bottom with a hammer. This is not a temporary job but can be made a permanent one by ordinary care.

This "stunt" saves a world of time and taking the set out to the shop. (A study of the hookup will show why this scheme works.)

In receivers of the model 130 series of Majestic, a very bad noise will sometimes be encountered (a boop-doop noise) when the tuning dial is moved. A little graphite or vaseline under the prongs which ground the rotors of the condenser gang will remedy this oscillation.

Upon making a call in connection with the model 52 Majestic, always shellac the dial light when putting in a new one (a well-known "job" to any one who has had it to do). A little shellac, or wax melted in the right place will save 45 minutes labor a little later on (its a job you can't charge much for anyway).

A speaker which reproduces high notes badly (especially the Majestic model 70 series receivers) may not always be due to a bad cone—many times the field coil is loose in "the pot." A little packing with pasteboard on the back end will correct the condition after everything else has failed.

An open field coil can be repaired (nine times out of ten) if you will take off the end plates of same. You will usually find several small green spots (corrosion) on each end of the coil.

Break these and solder. One of them is to blame.

Nearly always the "open" is upon one end and very seldom "inside" the coil. (The air of course gets to the outside easier.)

When no grid voltage is found upon any of the R.F. tubes, first test every tube for "shorts" as one shorted tube kills grid voltage on all R.F. tubes.

Many times the radiotician will find low voltages due to the winding of the voltage regulator being wound with the wrong size resistance wire.

It is well known by all real radioticians that this is important. A 70 Majestic and a 90, also nearly all other sets use different values of resistance, depending upon the current drain, etc.

Where low voltage is encountered in the set with a normal line voltage—look at the regulator.

Voltage can be raised or lowered at will by a little intelligent work with the voltage regulator. This is a simple matter which is overlooked by most Service Men.

When aligning a model 70 Majestic you will notice aligning condensers upon the side of each R.F. condenser as well as between each tube.

First align each of these side condensers "in" before using your dummy tube and aligning the others "out."

In other words, align each of these side condensers for maximum output and then use your balancing tube to align the other condensers (between the tubes) to minimum.

STEWART-WARNER

IN Stewart-Warner sets the R.F. bypass condenser value is very critical. On a set which is weak in volume and sensitivity try different capacities. When the right condenser is placed in the circuit, the set will "jump at you." These are fiber inclosed condensers (fire cracker type). If a metal cased condenser is used, it must be well taped or insulated.

O. A. GULLEDGE,
(Box 1182),
McFarland Furniture, Inc.,
Campbell Arcade,
Vero Beach, Fla.

LYRIC MODEL D

A TEMPORARY repair for Lyric model D receivers, when the push-pull transformer between the 27 audio tube and the two 45's goes "west," is shown in Fig. 5. An ordinary audio transformer is connected with its primary between the plate and "B" supply of the 27 tube and its secondary between the two grids of the 45's. A 2,000 ohm resistor is connected from one 45 tube grid to the chassis.

While the action resulting from this wiring is not equal to the original circuit, due to the fact that push-pull action is not obtained, the results are very satisfactory, for a temporary repair.

EDWARD J. BROCKWAY,
Wildwood, N. J.

BOOK REVIEW

28 TESTED METHODS FOR MAKING EXTRA MONEY. Published by National Radio Institute, Washington, D. C. First edition. Size, 5 3/4 x 8 1/2 ins.; 56 pages, 82 illustrations, paper cover. Price, 50c.

The man who is earning his living by servicing radio receivers will find this little volume both interesting and valuable. Its main purpose is to point out how the radio technician can increase his income by widening his scope of activities. Wide-awake men will, no doubt, profit by the suggestions and hints.

The 28 methods are as follows: (1) How to Erect an Outside Antenna, (2) Where to Place the Receiver, (3) How to Install Line Filters to Prevent Noisy Radio Reception, (4) Installing a Noise-Reducing Antenna System, (5) How to Erect a Noise-Reducing Antenna to Accommodate Up to Four Receivers, (6) How to Install an Aerial Between House and Garage; or House and Tree, (7) How to Make and Erect a Good Aerial Mast, (8) How to Install an Indoor Aerial or Aerial Device, (9) How to Install a Permanent Lead-in and Lightning Arrestor Device, (10) How to Install a Noiseless Short-Wave Antenna, (11) How to Select and Replace Tubes in a Receiver, (12) How to Start a Spare or Full-Time Radio Business, (13) How to Install Tone Controls, (14) How to Add a Second Reproducer to a Radio Receiver, (15) How to Make and Install a Wave Trap to Reduce Station Interference, (16) How to Install a Police and Short-Wave Adapter, (17) How to Increase or Decrease the A.C. Power Supply Line Voltage, (18) How to Install an Automatic Line Voltage Regulator, (19) How to Operate 25 Cycle Apparatus on 60 Cycle Current, (20) How to Operate 110 V. A.C. Receivers on D.C. Lines, (21) How to Operate Any Battery Set on a 22 V. Farm Lighting System, (22) Restoring Marred Radio Cabinets, (23) How to Install a Simple Radio Circuit to Amplify Phone Conversation Without Disturbing Wiring of Telephone Company, (24) How to Install Duplex Convenience Telephones, (25) How to Install an Antenna for an Automobile Receiver, (26) How to Install an Auto Radio Receiver, (27) Replacing "B" Batteries with a Standard "B" Eliminator in Automobile Receivers, (28) How to Install a Charger for Automobile Storage Batteries.

This book, which has been prepared by the instructors in one of the largest radio schools in this country, covers the above subjects in a concise and easy-to-read manner. It should be serviceable to all practical men.



Do you know anyone who has ever had to replace

LYNCH RESISTORS

?

Lynch Metallized Resistors are delivering complete satisfaction in all parts of the world under every kind of climatic handicap.

The NATIONAL COMPANY, in supplying the Communication Receivers for the BYRD EXPEDITION, employs LYNCH Resistors exclusively, because all risk of breakdown or unsatisfactory performance must be eliminated.

Lynch Power Wire Wound Resistors have been specified by the United States Navy, after most rigid tests, for replacement in the Echo Sounding Systems of more than 100 of Uncle Sam's naval vessels of all types, such as submarines, sub-chasers, light cruisers, battleships, supply vessels; also navy yards and submarine bases.

Free Descriptive Folder Upon Request

Thanks for the minute!

LYNCH MANUFACTURING CO., Inc.
51 Vesey Street, New York, N. Y.
Makers of the Lynch Noise-Reducing Antenna Systems

SERVICEMEN RADIO DEALERS

SEND FOR THIS

FREE CATALOG!

IT'S CHOCK-FULL

of BARGAINS FOR YOU

Radio Dealers and Servicemen can't afford to be without this book. It offers marvelous buys in Radio Sets, Long and Short Wave Apparatus, Servicemen's Repair and Replacement Parts, Electrical Goods, Sporting Goods.

Just Off The Press!

Be among the first to have the pick of great bargains. Mail this coupon now!

RADIO CIRCULAR CO., INC.
225 Varick Street
New York, N. Y. Dept. RC-134

Please send me free of charge and without obligation, your latest catalog.

Name

Address

City..... State.....



In ONE VOLUME of over 2,300 Pages
Extra Heavy Cover-Looseleaf Bound

Buy this Big Volume on our New
DEFERRED PAYMENT PLAN

Here are two of the most surprising announcements that we have ever made to the radio trade and we know that it is such good news that every radio man will be greatly enthused.

FIRST—that the three editions of the OFFICIAL RADIO SERVICE MANUALS have now been combined into one big volume of over 2,300 pages.

SECOND—that this new single volume of consolidated radio circuit diagrams and complete radio servicing course can be bought on a deferred payment plan—and at a big saving.

It is needless to say how valuable the OFFICIAL RADIO SERVICE MANUALS have been to members in every branch of the Radio Industry, and how many thousands of each edition have been sold to manufacturers, jobbers, dealers, Service Men and experimenters. But we must emphasize this one fact: Service Men now realize that they are tremendously handicapped without the full set of Gernsback Manuals. So much so, that those who have purchased only one or two volumes, are NOW ORDERING THE MISSING BOOKS. They want their files to be complete.

The complete book gives you a volume of over 2,300 pages with over 5,500 diagrams, charts and photos. There are absolutely no pages or illustrations or diagrams duplicated. There is no radio book published today which is so modern, up-to-the-minute, and which contains so much useful information as is to be found in this single volume. It is a book that will outlast any other radio book in print. Look carefully at the illustration of the complete edition on the top of page. It measures 9" wide, 12" long, 4½" thick.

Included in this volume is a complete radio servicing course. This course covers every step needed to learn the servicing business . . . from starting in business . . . materials needed . . . and how to go about servicing receivers and repairing other radio equipment. This course in itself, is actually worth the price of the entire book.

Our new plan now enables every radio man to get this single volume—a Complete Directory of all Circuit Diagrams, of over 2,300 pages, on deferred payments. You can order this book immediately—get it in a few days, and use it while you are doing servicing work. You can make the first few calls pay for the entire cost of the book.

For you to get this book is quite simple and it is sent to you as soon as your order is received. You pay for it in small monthly amounts which can be taken from your earnings. If you were to buy the three volumes separately, the total cost would be \$17.00, including the supplements.

Now you can get the
 1931 OFFICIAL RADIO SERVICE MANUAL, with Supplements,
 1932 OFFICIAL RADIO SERVICE MANUAL, with Supplements,
 and the 1933 OFFICIAL RADIO SERVICE MANUAL Complete
 at a big saving.

THE SPECIAL NEW PRICE FOR ALL THREE MANUALS, WITH SUPPLEMENTS, IN ONE VOLUME, WITH HEAVY BINDER IS ONLY

\$14.00

You buy this book this way—
 Send \$3.00 with order—
 Pay \$5.00 to Express Company upon receipt of book.

Send \$3.00 thirty days after receipt of book.
 Send \$3.00 sixty days after receipt of book.
 Total \$14.00.

IF THE ENTIRE AMOUNT IS SENT WITH YOUR ORDER, WE WILL ALLOW YOU A 10% DISCOUNT. THIS CAN BE DEDUCTED FROM YOUR REMITTANCE.

IMMEDIATE SHIPMENT

Mail Coupon Today!

GERNSBACK PUBLICATIONS, Inc.,
 96-98 Park Place, New York, N. Y.

Gentlemen:

In accordance with your Special Offer, I enclose herewith \$3.00 as first payment toward the One-Volume Radio Manual. Please forward it to me promptly. Upon receipt of the book, I shall pay express company \$5.00. Thirty days later I shall send you \$3.00, and sixty days after receipt of book, I shall send you my last payment of \$3.00.

If you want to take advantage of the Special Discount of 10%, remit only \$12.60 with this coupon.

Name _____
 Address _____
 City _____ State _____

RC-104

OVER 2,300 Pages
5,500 Illustrations

THIS IS THE GREATEST SINGLE VOLUME RADIO BOOK IN PRINT TODAY

GERNSBACK PUBLICATIONS, Inc.

96-98 Park Place

New York, N. Y.

DIX ANNEES DE T. S. F. (Ten Years of Radio). Published by Étienne Chiron, Paris, France. First edition. Size, 6½ x 10 ins.; 180 pages, 70 illustrations, paper covers. Price 15 francs—\$1.00.

This interesting volume which is a timely memoir to General Ferrié, has been written by ten men well known in their respective fields, in France. The book is written in French and is non-technical in its scope.

The first part reviews the last ten years as recorded by "The Society of Friends of Radio" in THE ELECTRICAL WAVE. The second chapter concerns Spark Transmitters, Arcs and Alternators for long-wave transmission; it tells how these methods have become practically obsolete within the last ten years. The third chapter describes the advances made in Vacuum Tube design. The fourth tells about short waves and how great distances are covered on the high frequencies. In this section is mentioned Multiplex radio transmission for secret telephony. The sixth chapter covers transmission on various frequencies and the uses for each frequency spectrum. The seventh is a history of the past ten years in radio broadcasting; and the last three cover Receivers, Radio in Aviation and The Stabilization of Frequencies, respectively.

This book is a fitting memoir to that famous scientist and pioneer in radio, General Ferrié, whose untimely death brought to an end a brilliant career.

LES REDRESSEURS DE COURANT (Current Rectifiers), by R. de Bagneux. Published by Étienne Chiron, Paris, France. First edition. Size, 5½ x 9 ins.; 128 pages, 53 illustrations, paper cover. Price 10 francs—\$0.70.

This book contains a semi-technical description of the types of rectifiers and rectifying systems used for converting low-frequency alternating currents to pulsating direct current.

Included in the explanations are the following types of rectifiers: non-synchronous motors with dynamos, synchronous motors with dynamos, commutator type rectifiers, vibrator rectifiers, electrolytic rectifiers, metal oxide rectifiers, vacuum tube rectifiers, mercury arc rectifiers, hot-cathode mercury vapor rectifiers, thyratrons, pressure-type metal rectifiers, and selenium rectifiers.

The description for each type includes a simplified theoretical discussion, an outline of the ordinary uses of the particular type and a semi-technical consideration of the characteristics.

Radio fans and Service Men who are acquainted with French will find this book an interesting addition to their library of reference books.

LA SURDITÉ ET L'ACOUSTIQUE MODERN (Hearing Aids and Modern Acoustics), by P. Hemardinquer. Published by Étienne Chiron, Paris, France. First edition. Size, 5½ x 9 ins.; 112 pages, 65 illustrations, paper. Price, 10 francs—\$0.70.

This book, written in French, covers that very interesting subject of overcoming deafness by mechanical and electrical devices. The author is well known for his researches in the sound and acoustic fields and is well fitted to write on this subject.

The book starts with a general discussion of the peculiarities of deafness and tells which varieties of the malady can be helped by mechanical devices. Following this is a résumé of the numerous types of equipment available for alleviating deaf conditions, including the Ossophone invented by Hugo Gernsback.

This volume gives a complete summary of the subject, without being too technical, and should be of interest to the technician and experimenter.

Build the Beginner's Short-Wave Set—to be described in the forthcoming issue of Radio-Craft.

ELECTROLYTIC CONDENSERS AT HIGH VOLTAGES

WILLIAM MASON BAILEY*

THE economical capacity inherent to the electrolytic condenser may be applied to the rectifying end of the amateur and even the professional transmitter provided due precautions are observed. In fact, for the past two years electrolytic condensers have found a place in amateur radio work, and splendid results have been obtained by users fully acquainted not only with electrolytic condenser technique but also with the operating voltages dealt with. Hence a few notes at this time may prove well worth while.

First of all, there are in general use only five voltages employed in amateur transmitting practice, namely, 600, 1,000, 1,500 and 2,500 V., as delivered to the load. A condenser in order to be suitable for such applications should be capable of withstanding these operating voltages without any sputtering or similar troublesome phenomena. Since for the present the available radio electrolytic condensers are limited to a working voltage of 500, it is obvious that two or more units must be wired in series to obtain the necessary working voltage. Also, in series operation the effective capacity is represented by the capacity of a single unit divided by the number of units in series. Thus with three 500 V. units wired in series to operate in a 1,500 V. rectifier circuit, the effective capacity will be one-third of 15 mf. or 5 mf.

The difficulty usually experienced with condensers of any type when employed by amateurs may be traced to lack of knowledge regarding actual working conditions as well as the limitations of the condensers. For this reason the user should make sure that he knows definitely the peak or surge voltages that obtain in the circuit, and that these extreme voltages are fully matched by the working voltages specified by the makers of the condensers employed. Unfortunately, the voltmeter inserted in the rectifier circuit does not always indicate the correct operating voltage, due to circuit peculiarities. The actual peak voltage may be considerably higher, placing a severe strain on the condensers.

There are two classes of rectifying circuits in common use, shown in the accompanying diagrams. Fig. 1A illustrates the circuit most commonly used by amateurs, since this type of circuit will deliver a somewhat higher voltage for the same load and transformer voltage. The use of such a circuit especially with the now universally used mercury-vapor rectifiers places an enormous overload on the rectifiers and condensers. The untrained constructor usually blames both tube and condenser manufacturers, not realizing that the condensers may be operating at a voltage much higher than the meter usually associated with such equipment would indicate.

The circuit shown in Fig. 1B will increase the life of the apparatus enormously and, at the same time, provide a much better regulation. The only drawbacks to this circuit are the slightly higher transformer voltages required as well as the additional choke.

* Chief Engineer, Dubilier Condenser Corporation.

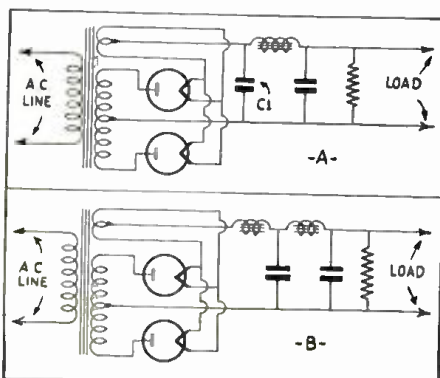

Fig. 1

The circuit at B is preferable to A.

RADOLEK'S NEW LINE OF AMPLIFIERS



This 15-WATT
3-STAGE MODEL

Dealer's Price
Less Tubes
ONLY

\$32.40

- PUSH-PULL 2A3s
- IMPROVED CLASS A PRIME
- 30 WATT SPEAKER FIELD SUPPLY

One of the finest 15 Watt Amplifiers ever produced—yet lower in price than previous Amplifiers far less efficient and well made. Most Power per dollar, with matchless Tone. For use with Microphone, Phonograph or Radio. Drives 3 large Dynamic Speakers, 8 small Dynamic Speakers, 3 Dynamic Horns, 130 Magentic Speakers, or 2,000 Headsets; or any combination of these. Furnishes 30 watts for Dynamic Speaker Field supply. No external chokes required. Has output impedance tapped at 3, 6, 9, 15, and 500 ohms. Gain at 1,000 cycles, 77DB. Frequency characteristic within 3DB, 50 to 8,000 cycles. Tubes used: 1-56, 1-57, 2-2A3s, 1-5Z3. Overall size 9x16x8 inches.

YOUR PRICE COMPLETE WITH CUNNINGHAM TUBES..... **\$39.67**

GET OUR BIG CATALOG

Radio Dealers and Servicemen: The new Radolek Profit Guide is now ready! Don't delay sending for your FREE copy. It is the most complete guide to Radio merchandise ever published. Lists over 6,000 various items—Replacement Parts, Tools and Materials, Testing Equipment, Money-making Specialties, Public Address Equipment and Radio Sets. Also contains many handy charts, lookups, tables, and diagrams that you will have use for every working day.

Fill Out and Mail the Coupon Today!

RADOLEK CO., 133 Canal Station, Chicago

I am a Dealer [] Serviceman []

I operate from Shop or Store []; from Home []

I own the following Test Equipment.....

My training and experience is:.....

.....

.....

.....

Name

Address

City State

.....

DIAMOND TUBES at BARGAIN PRICES

All tubes are R. C. A. Licensed and are Guaranteed for 90 days. Dealers and service men let us show you how you can increase your profits on tubes sales. Our tubes will improve the quality and tone of any set.

Type	Price	Type	Price	Type	Price	Type	Price
201A	.25	234	.65	58	.45	125M1	.85
226	.27	236	.50	59	.55	401	1.10
227	.27	237	.40	75	.65	403	1.25
245	.28	238	.45	77	.60	485	.50
171A	.28	239	.50	78	.60	182	.55
280	.28	41	.50	79	.75	183	.65
224A	.45	42	.50	281	1.10	210	1.25
235	.45	43	.75	82	.40	250	1.10
25	.45	44	.50	83	.45	247	.75
247	.45	46	.50	84	.65	217	.85
112A	.40	48	1.75	85	.50	6A7	.75
230	.50	49	.65	80	.55	617	.85
231	.50	55	.50	X99	.45	2525	.65
232	.65	56	.35	V99	.45	2A5	.65
233	.65	57	.45	222	.85		

No order accepted for less than \$3.00. Order from this adv. All prices F. O. B. factory. 20% deposit with all orders.

Radio Tube Exchange of America
160 Washington St., New York, N. Y.

SENSATIONAL- BIG BROADCAST Magazine Prices **SLASHED** Save 25% to 50%

RIGHT NOW is the time of the year when millions of subscriptions to favorite magazines expire. **RIGHT NOW** is the time to renew your subscription when prices, for a limited time only, have been sensationally reduced. Ordering at this time will mean a saving of several dollars for you.

In assembling these many combination subscription offers we have made it possible that our readers obtain standard, popular magazines at the lowest prices obtainable. Only by special arrangement with a group of famous publishers has this great combination of magazines been made available at the unusually low cost. **NOW** you should order—at money-saving prices. It is most appropriate at this time of the year to send your friend his favorite magazine. Read over the various combination offers, and see how we bring you double values for only half the price. Then order your magazines today. Prices are going up—this is your protection for one year. **RIGHT NOW** sit down and send us the list. If books are to be sent to individual people, mention specifically the name of the magazine and to whom and where it should be sent. Don't miss this wonderful opportunity. All prices quoted are for subscriptions in U. S. A. only. Canadian and Foreign subscriptions require additional postage.

OFFER NO. 1			
Radio Craft	\$2.50	OUR PRICE	
Radio News	2.50		
Regular Price	\$5.00		\$3.75

OFFER NO. 2			
Radio Craft	\$2.50	OUR PRICE	
Short Wave Craft	2.50		
Regular Price	\$5.00		\$3.75

OFFER NO. 3			
Radio Craft	\$2.50	OUR PRICE	
Everyday Science and Mechanics	2.50		
Regular Price	\$5.00		\$3.75

OFFER NO. 4			
Radio Craft	\$2.50	OUR PRICE	
Popular Mechanics	2.50		
Regular Price	\$5.00		\$3.85

OFFER NO. 5			
Radio Craft	\$2.50	OUR PRICE	
Popular Science	1.50		
Regular Price	\$4.00		\$3.35

OFFER NO. 6			
Radio Craft	\$2.50	OUR PRICE	
Modern Mechanix	1.50		
Regular Price	\$4.00		\$3.35

OFFER NO. 7			
Radio Craft	\$2.50	OUR PRICE	
Christian Herald	2.00		
Regular Price	\$4.50		\$3.50

OFFER NO. 8			
Radio Craft	\$2.50	OUR PRICE	
Photoplay	2.50		
Regular Price	\$5.00		\$3.85

OFFER NO. 9			
Radio Craft	\$2.50	OUR PRICE	
Life or Judge (Only One)	1.50		
Regular Price	\$4.00		\$3.25

OFFER NO. 10			
Radio Craft	\$2.50	OUR PRICE	
Delineator	1.00		
Regular Price	\$3.50		\$3.00

OFFER NO. 11			
Radio Craft	\$2.50	OUR PRICE	
Pathfinder	1.00		
Regular Price	\$3.50		\$3.00

OFFER NO. 12			
Radio Craft	\$2.50	OUR PRICE	
American Boy	2.00		
Regular Price	\$4.50		\$3.50

OFFER NO. 13			
Radio Craft	\$2.50	OUR PRICE	
Motion Picture	1.50		
Regular Price	\$4.00		\$3.25

OFFER NO. 14			
Radio Craft	\$2.50	OUR PRICE	
College Humor	1.50		
Regular Price	\$4.00		\$3.25

OFFER NO. 15			
Radio Craft	\$2.50	OUR PRICE	
Screenland	1.50		
Regular Price	\$4.00		\$3.25

OFFER NO. 16			
Radio Craft	\$2.50	OUR PRICE	
Silver Screen	1.00		
Regular Price	\$3.50		\$3.00

OFFER NO. 17			
Radio Craft	\$2.50	OUR PRICE	
Golden Book	3.00		
Regular Price	\$5.50		\$4.25

OFFER NO. 18			
Radio Craft	\$2.50	OUR PRICE	
Review of Reviews	3.00		
Regular Price	\$5.50		\$4.25

OFFER NO. 19			
Radio Craft	\$2.50	OUR PRICE	
Nature	3.00		
Regular Price	\$5.50		\$4.25

OFFER NO. 20			
Radio Craft	\$2.50	OUR PRICE	
Scribner's	4.00		
Regular Price	\$6.50		\$5.25

OFFER NO. 21			
Radio Craft	\$2.50	OUR PRICE	
Physical Culture	2.50		
Regular Price	\$5.00		\$3.25

OFFER NO. 22			
Radio Craft	\$2.50	OUR PRICE	
Boys' Life	1.00		
Regular Price	\$3.50		\$3.00

OFFER NO. 23			
Radio Craft	\$2.50	OUR PRICE	
Pictorial Review	1.00		
Regular Price	\$3.50		\$3.00

OFFER NO. 24			
Radio Craft	\$2.50	OUR PRICE	
Wonder Stories	2.50		
Regular Price	\$5.00		\$3.75

All Subscriptions Will Be Mailed to You Without Delay—Use the Coupon When Ordering



Makes an Ideal Gift for Anyone

Perhaps there is some friend out of town, or right near you, to whom you wish to carry your remembrance throughout the year. Then here is a good idea. Send him his favorite magazine, or one you know he will thoroughly enjoy. (You can even send a magazine subscription to your best lady friend.) A subscription to a magazine is always appreciated, and certainly brings remembrances. A courtesy card advising your friend of the kind donor will be sent to him or her bearing your name. Send one or more popular magazines to your friends or relatives.

over 50 GREAT COMBINATION SUBSCRIPTION OFFERS TO CHOOSE FROM on Your Favorite Magazines

The BIG "4" Offer

Grouped below are many of the outstanding magazines which can be taken in combination with RADIO CRAFT. The individual groups represent a substantial saving over the regular newsstand rate of all the books. ORDER TODAY.

Radio Craft Modern Mechanix Wonder Stories Christian Herald	OFFER NO. 25 1 year } 1 year } 1 year } 1 year }	ALL FOUR ONLY \$6.00	YOU SAVE \$2.50
Radio Craft Popular Science Delineator Pathfinder	OFFER NO. 26 1 year } 1 year } 1 year } 1 year }	ALL FOUR ONLY \$4.50	YOU SAVE \$1.50
Radio Craft American Boy Motion Picture College Humor	OFFER NO. 27 1 year } 1 year } 1 year } 1 year }	ALL FOUR ONLY \$5.00	YOU SAVE \$2.50
Radio Craft Screenland Silver Screen Life or Judge (Only One)	OFFER NO. 28 1 year } 1 year } 1 year } 1 year }	ALL FOUR ONLY \$4.75	YOU SAVE \$1.75
Radio Craft Golden Book Review of Reviews Nature	OFFER NO. 29 1 year } 1 year } 1 year } 1 year }	ALL FOUR ONLY \$7.00	YOU SAVE \$4.50
Radio Craft Scribner's Nature Pathfinder	OFFER NO. 30 1 year } 1 year } 1 year } 1 year }	ALL FOUR ONLY \$6.50	YOU SAVE \$4.00
Radio Craft Physical Culture Life or Judge (Only One) Boys' Life	OFFER NO. 31 1 year } 1 year } 1 year } 1 year }	ALL FOUR ONLY \$5.00	YOU SAVE \$1.50
Radio Craft Modern Mechanix Pictorial Review Nature	OFFER NO. 32 1 year } 1 year } 1 year } 1 year }	ALL FOUR ONLY \$5.60	YOU SAVE \$2.40

The BIG "Popular" Offer

RADIO CRAFT for One Year and your choice of a subscription to any two of the publications listed below, each for one year, at the special combination rate of **ALL 3 FOR \$4.15**

Motion Picture College Humor Screenland Silver Screen	Physical Culture Boys' Life Pathfinder	McCall's Delineator Pictorial Review Woman's Home Companion
--	--	--



Your Choice of One or More of These Popular Magazines

Everyday Science and Mechanics	Boys' Life
Radio Craft	Woman's Home Companion
Short Wave Craft	American Boy
Wonder Stories	Golden Book
Popular Mechanics	Screenland
Radio News	Silver Screen
Popular Science	Photoplay
Modern Mechanix	Motion Picture
Christian Herald	Pathfinder
Life	College Humor
Judge	Pictorial Review
Delineator	McCall's
Review of Reviews	Physical Culture
Nature	Scribner's

Take Advantage of These Big Subscription Saving Offers—**ORDER TODAY!**

RADIO CRAFT, 96-98 Park Place, New York, N. Y. RC-131
Gentlemen: Enclosed you will find my remittance of \$ for which please send me Combination Offer No., which consists of RADIO CRAFT and the following Magazines:
.....
Name Address
City State
(For Canadian or Foreign Subscription rates on any combination offer, write for cost of additional postage.)

Fill out this section of the coupon if magazine is to be sent to a friend. DO NOT DETACH FROM OTHER HALF OF COUPON. If several magazines are to be mailed to friends, make duplicate coupons of this section only, one for each magazine to be sent. Write on plain white sheets.
Please send the (Name of magazine) to
Name
Address
City State
Mention that it is sent by
(Print your name clearly)

ATTENTION SERVICE MEN!

The Ideal Spraying Outfit for all Kinds of Commercial and Professional Work

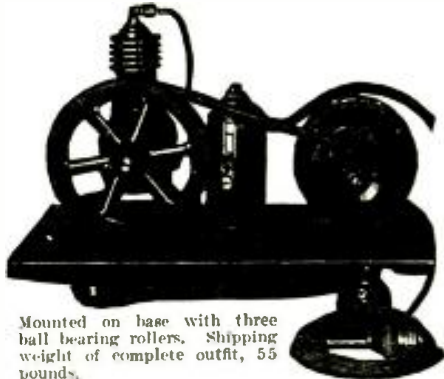

Mounted on base with three ball bearing rollers. Shipping weight of complete outfit, 55 pounds.

\$ 24⁵⁰
COMPLETE
Formerly Sold for \$68.50

This is the ideal outfit for all around spraying work wherever current is available. With this electric sprayer you can spray paint, varnish, duco, enamel, lacquer, insecticides, etc., with the speed of five men. You can move it from one room to another with ease. Simply insert plug into electric socket and this marvelous machine is ready to do a man-size job—and do it efficiently. This electric portable sprayer saves its cost over and over again on your own work. It will make money for you doing jobs for others.

This outfit comes completely equipped, nothing else to buy. It includes the following equipment: GV full-liquid pressure type adjustable gun. Non-clogging nozzle. Fan and round spray tips. 10" spread. ¼ H.P., 110 volt, 60 cycle AC motor. Air filter tank. Kellogg Air-Cooled Compressor, size 1¾ x 1¾. Connectors and 15 ft. hose, plug, cord and five spray jars.



Price of complete outfit with gun.....\$24.50
 Price of outfit without motor.....19.50
 Price of spray gun only with five jars.....3.95
 (This spray gun alone is valued at \$20.00)

Kellogg Air-Cooled Compressors at less than half price!

Nationally known for their exceptionally high quality. We offer four different sizes at prices that represent the buying opportunity of a lifetime. All Compressors furnished with "V" pulleys.

Size	Maximum Pressure	Speed	Motor	Price
1¾x1¾	75 lbs.	600	¼ H.P.	\$ 6.50
1x2½	100 lbs.	600	¼ H.P.	8.50
2x2	125 lbs.	600	1/3 H.P.	10.50
2¼x2	175 lbs.	500	1/3 H.P.	12.50



HEAVY DUTY DRILLS

Heavy Duty ¾" Drill—110 Volt Universal Motor
 An unusual Bargain! Regular price \$22.50

Our price \$12.95

We Have No Catalog—Order From This Page

Be sure to state shipping point if express or freight is not in your town. Enclose bank draft, cashier's check, post office money order or personal certified check. No. C.O.D.'s.

WELLWORTH TRADING CO.
 111 West Lake Street, Chicago, Ill.

RC-1

I enclose \$..... for which please send me the following by Express collect:

Name
 Address City State

• Index to Advertisers •

A	
Aerovox Corporation.....	426
Alden Mfg. Co.....	432
Allied Radio Corp.....	426
American Technical Society.....	422
Arco Tube Company.....	434
B	
Bud Speaker Company.....	421
Budstein-Applebee Company.....	430
C	
Central Radio Laboratories.....	437
Clarostat Mfg. Co.....	420
Classified Section.....	440
Coast-to-Coast Radio Corp.....	420, 426, 428
Coyne Electrical School.....	385
E	
Electrad, Inc.....	427
Equipment Design Company.....	431
F	
Fordson Radio Mfg. Co.....	430
G	
General Transformer Company.....	419
Grenpark Company.....	447
H	
Hammarlund Mfg. Company.....	437
Harrison Radio Company.....	428
Hygrade-Sylvania Corp.....	429
I	
International Resistance Company.....	423
J	
Jordan Radio Mfg. Co.....	431
L	
Leed's Radio Company.....	432
Leotone Radio Company.....	428
Lincoln Radio Corporation.....	431
Lynch Mfg. Company.....	441
Mc	
McGraw-Hill Book Company.....	434
M	
Midwest Radio Corp.....	Back Cover
N	
National Radio Institute.....	Insert
National Security Association.....	440
National Union Radio Corp.....	427
P	
Pembleton Laboratories.....	422
Polk & Co., R. L.....	437
Popular Book Company.....	438
Postal Life & Casualty Insurance Company.....	440
Postal Radio Corp.....	422
Precision Resistor Co.....	424
R	
Radio Circular Company.....	441
Radio City Products Company.....	435
Radio Trading Company.....	448
Radio Training Association of America.....	424
Radio Tube Exchange of America.....	443
Radolek Company.....	443
RCA Institutes, Inc.....	437
RCA Radiotron Co., Inc.....	417
RCA-Victor Co., Inc.....	435
Readrite Meter Works.....	425
Remington Rand, Inc.....	435
S	
S. O. S. Corp.....	430
Sexology.....	440
Shalleross Mfg. Company.....	420
Shure Brothers Company.....	428, 439
Silver, Inc., McMurdo.....	Inside Front Cover
Sprayberry, F. L.....	428
Stewart-Warner Corp.....	426
Sun Radio Company.....	434
Supreme Instruments Corp.....	Inside Back Cover
T	
Triplett Elec. Instruments Co.....	433
Truman Radio Shop.....	424
Try-Mo Radio Corp.....	430
U	
Universal Microphone Company.....	422
W	
Wellworth Trading Company.....	436, 446
Westinghouse Elec. & Mfg. Company.....	421
Weston Electrical Instrument Corp.....	423

(While every precaution is taken to insure accuracy, we cannot guarantee against the possibility of an occasional change or omission in the preparation of this index.)

\$50,000 SPEAKER CLEARANCE SALE!

SPECIAL - SALE - FEATURE FARRAND INDUCTOR DYNAMIC



The Ideal Short Wave Receiver Speaker:
Eliminates Hum and Line Noise:
Draws Less Current:

Absolutely Genuine Farrand:
Compact in Size:
Brings in the Very Weak Short Wave Stations:

Do not confuse this model with the various similar types on the market, posing as Farrands. This is the true Farrand Inductor Dynamic. Its adaptation to Short Wave Radio Receivers has proven a popular step. The most inaudible stations are brought in with remarkable clearness without the customary noise and hum of regular dynamic speakers. Has two magnets parallel to each other with a bracket placed between them to facilitate mounting. Overall 9".

\$3.95

BOSCH SPEAKER CABINET



Will accommodate any magnetic or dynamic chassis up to 10" in diameter. A beautiful walnut cabinet artistically and extensively finished. It was built by one of the foremost manufacturers of cabinets. Grill contains a gold bronze cloth for contrasting color scheme.

Dimensions 12 1/2" high, 12" wide, 10" deep.

Price **\$1.75**

JENSEN



Model D-7, A.C. DYNAMIC

Widely used as an additional speaker in many homes, as well as on public address systems. Will handle an enormous amount of volume without distorting or rattling. Equipped with a 280 rectifier tube. The speaker measures

12 1/2" high, 11 3/4" wide, and 7 7/32" deep. Baffle opening required, 10". Supplied complete A.C. Model. Price. **\$8.95** D.C. Model **\$6.95** with tube.

PEERLESS



A.C. and D.C. DYNAMIC SPEAKER CHASSIS

Adaptable for the most powerful amplifier. Equally suited for use with any receiver employing the average type of audio amplification system.

using as low as 90 volts "B" has a 1,000 ohm field and a push-pull output transformer; A.C. model used a dry rectifier system with a hum condenser for minimum A.C. hum.

Dimensions—12" high, 8" deep. A.C. Model. Price. **\$8.95** D.C. Model. Price. **\$6.95** 6 Volt. Price..... **\$7.95**

Limited Quantity!

GENUINE R. C. A. MAGNETIC CHASSIS



This chassis is the identical one used in the R.C.A. 100A-100B and 103 Speakers which list for as high as \$35.00. Note built-in output transformer which permits use of 450 volts without distortion, rattling or blasting. Generous oversized magnet. The thick armature is accurately centered, the sturdy metal frame is lined with a special self-balling fabric, greatly improving acoustic properties of this sensational speaker. Note the corrugated surface of the cone, an exclusive feature—enhances perfect reproduction qualities considerably; most compactly made; 9" outside diameter, 4 1/2" deep overall.

Price. **\$2.75**

Price Going Up. Buy Now!

Stromberg-Carlson

MAGNETIC PICKUP



The season for public address amplification is here. For perfect tonal quality and service insist on a genuine STROMBERG-CARLSON PICKUP. Little has to be said about it—Stromberg-Carlson quality is known the world over. Price includes a Stromberg-Carlson Head, Arm, Matching Transformer, Pickup Plug and 20-Foot Insulated Extension Cord. BUY NOW! This Low Price For a Short Time Only!

Price Complete **\$5.50**

FARRAND 12" MODEL INDUCTOR DYNAMIC



The 12" models have two magnets standing upright, with a bracket on the bottom to ease mounting. Dimensions of the 12" model: 12" high and 6 1/2" deep. (12" Model)

Our Price **\$5.95**

OXFORD A.C. and D.C. CONCERT

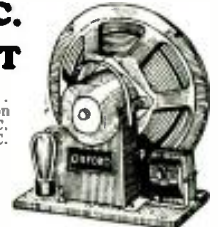

11 1/2" concert model. Three point suspension balanced cone types. A.C. uses 280 rectifier. D.C. models have a field resistance of 2,500 ohms. Output transformer may be had for single or push pull output tubes.

A.C. with Tube..... **\$5.75**
D.C. Model **\$4.50**

OXFORD A.C. or D.C. Auditorium DYNAMIC

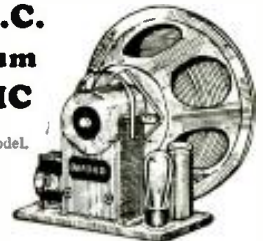

11" auditorium model. Takes a baffle with a 12 1/2" opening. Oversize frames with extra gauge wire in the field coil, which gives the speaker higher field strength and permits greater energization. D.C. model has a 4,000 ohm field which can be energized from the power packs of amplifiers or from 110 volt D.C. line.

A.C. with 280 Tube..... **\$9.95**
D.C. Model **\$7.95**

All orders are F. O. B. New York, and subject to prior sale. Terms: A deposit of 20% is required with every order. Balance may be paid on delivery. Deduct 2% if full amount is sent with order.
DO NOT SEND FOR CATALOG

GRENPARK COMPANY

245 Greenwich St.

Dept. RC

New York, N. Y.

RTC's Big January SPECIALS

Every month we list on this page a few STAR* items which are not listed in our catalog. These are all specials on which the quantities on hand are not sufficient to catalog them. *Once sold out, no more can be had.* ORDER NOW—TODAY.



No One in Radio Undersells Us!

STOP SHOPPING—the lowest prices are right on this page. *No one undersells us.* We meet any price on any new merchandise. Order direct from this page and save money. 100% satisfaction on every transaction. Take advantage today of these special offers.

★ Colonial Remote Control Attachment COMPLETE . . . NOTHING ELSE TO BUY

Imagine the convenience of just sitting back in an easy chair or lying in bed and merely by pressing a series of buttons, starting the radio located in a far off room or hidden away in the basement. Not only that, but selecting one of ten stations from a remote point. If this is also the case of your entire radio, the remote control is a machine designed to tune your radio automatically. Why not take advantage of it, especially when it is priced more than 300% below its original list value.

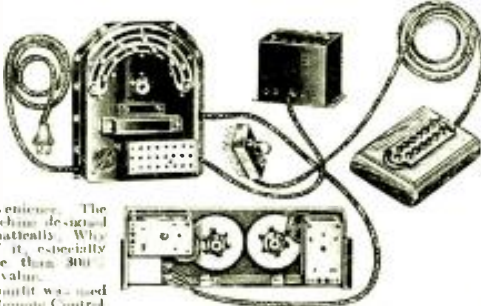

This remote control outfit was used on one of the Colonial Homecoming Receivers which sold for more than \$300.00; yet you or anyone at all handy with tools can attach it to your own radio. You can then hide the radio either in the closet, basement, or some other out-of-the-way place and extend wires to any number of speakers strategically located in various parts of your apartment. Imagine the surprise of your friends or guests at dinner or at special gatherings, when, by merely pressing a button the room is gradually flooded with beautiful music or other entertaining programs, by the hidden speakers. Aside from being a novel idea it is also a very practical one.

RADIO SERVICE MAN and CUSTOM SET BUILDER— HERE IS YOUR OPPORTUNITY

You need not mention the words "remote control" to your customer and immediately you command his entire interest and attention. You are able to do this because the idea to him, is new and because it immediately implies expensive equipment. However, when you inform him that you can construct or ADAPT HIS RECEIVER FOR REMOTE CONTROL OPERATION for only a few dollars more, his interest will most certainly materialize into an order. We need not give YOU any more talking points on this subject because you probably can mention up more than ten.

EXTREMELY SIMPLE TO OPERATE

The outfit comprises 14 small motors (one for turning the tuning condenser and the other for turning the volume control), 10 position selector switch for selecting 10 different stations, a step-down transformer for energizing the motors and a 14 button control board (10 buttons for the 10 stations, two buttons for increasing or decreasing the volume and two buttons for silent tuning). A pilot light in this control board indicates when the receiver is operating.

If the shaft of the tuning condenser and volume control of your present receiver can be extended so that the commutator switch section and one of the motor gears can be slipped over the tuning condenser shaft and the other motor gear on the volume control shaft then you can easily adapt this outfit to your receiver DIRECTLY without any further changes. With some sets it may be necessary to remove the volume control entirely from the chassis and mount it directly on the shaft of the volume control motor. Custom set builders need have no hesitations about this remote control, inasmuch as they can design the physical layout of their sets in conformity with this equipment. The illustration clearly shows all component parts of this complete remote control system. Shipping weight 18 lbs.

No. 1789 Colonial Complete Remote Control Outfit
YOUR PRICE, Only

\$5.95

BUILD "NEW DEPENDABLE" TUBE TESTER

Sold Either Wired or in Kit Form

Here indeed is your opportunity to build one of the finest tube checkers ever designed—an instrument which is **MORE** in every sense of the word. Will test all the latest type tubes, including those with 7 AND 8 PRONGS—DIRECTLY—without the use of a single adapter!

The "NEW DEPENDABLE," despite its high degree of accuracy, is extremely simple to operate. Both plates of the 80—82, 85 and other rectifier tubes are readily tested without the use of a "second plate" button.

The instrument employs a high-grade, D'ARSONVAL TYPE MOVING-COIL METER, insuring thereby extreme accuracy. This instrument will check more than 120 different tubes and even those which have not as yet been placed on the market. The tube tester is amply guarded against tube "shorts," which condition is indicated by the flashing of a small pilot light. All component parts are mounted on a beautifully etched panel and the entire instrument placed in a sturdily constructed, leatherette covered, carrying case. For operation on 105-125 volts, 50 60 cycles, A.C. This instrument is available either in kit form or completely wired and tested, ready to use. Shipping weight 3 lbs.



No. 303 "New Dependable" Tube Tester, completely wired and tested.
YOUR PRICE..... **\$18.77**

No. 303 A "New Dependable" Tube Tester in kit form.
YOUR PRICE..... **\$14.77**

NEW Service Men's Wire Wound Fixed Resistor Kit Only 100 Kits Left

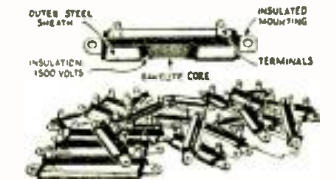

You have probably never seen a resistor of this type before. It is new, it is radically different from other resistors, both in construction, accuracy and maintenance of calibration. These resistors are set in steel or brass and are made in one piece. The wire resistance element protrudes in a helical and provides 24 ft. of resistor in the type you have used one and one quarter from end to end. The kit consists of 24 resistors, only four of which are duplicated. In other words there are more than 20 different values. If these units were bought individually, they would cost more than \$6.50.

NOTE: The kit contains one each of the following values: 20 ohms, 25, 40, 50, 60, 75, 100, 150, 200, 300, 400, 500, 1,250, 1,500, 2,000, 2,500 and 3,000, and ten each of the following: 200 ohms, 500, 750 and 1,000.

No. 1788 Service Men's Wire Wound Fixed Resistor. YOUR PRICE **\$2.76**

A Real Microphone at the Price of a Toy

Here is the largest value ever offered in a commercial type microphone! An unusually large two-button microphone, ruggedly constructed and designed especially for broadcast purposes. Frequency range 30 to over 5,000 cycles—adequate for all speech and music reproduction. EXCELLENT FOR PUBLIC ADDRESS WORK. Stretched cushioned diaphragm of aluminum with pure gold center contacts on buttons and diaphragm. Standard 200 ohms per button. Finished in beautiful polished chrome. Net weight 1 1/2 lbs. Ship weight 2 1/2 lbs.

No. "F" 2 Button Mike **\$4.94**
YOUR PRICE



FREE RADIO AND SHORT WAVE TREATISE



Avail yourself now of the opportunity to receive the FREE 1933 Radio and Short Wave Treatise. 116 solid pages of useful information, radio items, diagrams and illustrations. NOT POSTAGE.

JUST ANOTHER CATALOG. Contains a large editorial section with valuable information for radio owners here in the continental United States. Among the special technical advertisements listed are the following:

HERE IS A PARTIAL LIST CONTENTS

- Fundamental Principles of Radio—Ohm's Law—Discussion of New Tubes—Constructing a "Triple-Twin" Amplifier—All about Superheterodynes—Eliminating Man Made Interference—Constructing a Two-Tube Short-Wave "Coke-Setter" Receiver—\$3.00 Prize Suggestions—Radio Kinks, etc., etc.

WRITE TODAY. Enclose 4 cents for postage. Treatise sent by return mail.

Over 100 New Hook-Ups, Etc. 1000 Illustrations.

NEW READRITE MODEL 710 ANALYZER TESTS LATEST TYPE 6 AND 7 PRONG TUBES

This new Readrite precision instrument embodies features which have been desired in any instrument built for service work: (1) low cost, (2) simplicity of design, (3) accuracy of measurements, (4) ruggedness of the complete unit. It is needless to add that the kit is capable of testing anything from old battery models to the latest screen-grid, pentode, and multi-micro tubes.

The "Model 710" is an extremely rugged device. The outside dimensions of the carrying case are only 10 1/2 by 7 1/2 by 3 1/2 inches. The analyzer contains a D.C. voltmeter, an A.C. voltmeter and a milliammeter. The D.C. voltmeter has four ranges: 0 to 10, 0 to 60, 0 to 300 and 0 to 900 volts. The A.C. voltmeter has three ranges: 0 to 10, 0 to 140, and 0 to 700 volts. The milliammeter has two ranges, up to 45 mill. reading and the other for 150 mill. This variety of ranges makes it possible to test every conceivable radio circuit; high voltage, acrobatism of power transformers, current drain of all radio tubes, including the high power 250 and 311 tubes, etc.

CONVENIENT SELECTOR SWITCH. The instrument is equipped with a ten position selector switch, by means of which readings may be obtained of "0" volts, "0" volts reversed, "K" volts, "K" volts reversed, plus voltage, percentage of softening, A.C. voltmeters, in addition with the analyzer to provide "50" bias for grid tests, continuity tests, etc.

RECYCLES "MULTI-MUS" "57's and "58's" "50 RECTIFIERS, Etc.—There are four sockets on the panel of the analyzer to take care of the four, five, six and seven Prong Tubes. There is a "grid test" push-button. Such sockets are available for the individual use of all meters, externally, in every range. There is a screen-grid pin jack, and there are two pin jacks for connecting the external battery. Both plate and 80-type resistors may be tested by use of a special adapter furnished. Charts are provided for measuring resistance and capacitance. The analyzer is furnished complete with test leads, connecting cables, Burgess 4 1/2-volt battery, several battery adapters, C.V. to C.V. adapter, 80 rectifier adapter and resistance and capacity charts. Shipping weight, 8 lbs.

Model 710 Analyzer. List Price, \$27.50.
YOUR PRICE **\$16.19**



WE ARE A WHOLESALE HOUSE AND CAN NOT ACCEPT ORDERS FOR LESS THAN \$3.00. If C. O. D. shipment is desired, please remit 20% remittance, which must accompany all orders. If full cash accompanies order, deduct 2% discount (except on Readrite 710 Analyzer). Send money order—certified check—U. S. Stamps.

ORDER FROM THIS PAGE You will find special prices from time to time in this magazine. Get our big FREE catalog for the greatest Radio Bargains. Should you wish goods shipped by parcel post, be sure to include sufficient extra remittance for same. Any excess will be refunded.

Radio Trading Company 102 Park Place New York, N. Y.



The Flexibility of the Telephone Switchboard



Telephone subscribers are constantly changing. But no matter how many new subscribers, the switchboard has the flexibility to enable the operator to promptly plug in each call—each connection. That same amazing flexibility is built into Supreme Instruments. Observe how much like a switchboard are the panel and connections of these instruments. See how instantly the Supreme Free Reference Point System of Analysis directly plugs in any test on the Model 444 or the Model 333 . . . And the smooth facility with which connections for all tests are dialed on the Master Diagonometer and the Model 91. Use your Instruments year after year and enjoy today's flexibility that so readily adapts each Instrument to tomorrow's radio construction. Flexibility that makes Supreme a long-time investment—safe from the obsolescence of short-sighted engineering.



**Model 444 FIVE UNIT
RADIO TESTER**

The straight-forwardness of the Supreme Free Reference Point System of Analysis of the Model 444 Five-Unit Radio Tester and of the Model 333 Analyzer is comparable to that of the telephone switchboard. The operator actually sees the connections as they are made with test leads or connectors . . . No mental confusion as to what is happening! For the utmost in straight-forward procedure, practical utility, and time-saving simplicity, you must have one of these testers.



**Model 333 SUPREME
ANALYZER**

The Supreme Free Reference Point System of Analysis adds the flexibility of switchboard connections to the advantages of plate current measurements, resistance and potential measurements through an analyzing cable . . . An unbeatable combination! The Free Reference connections are accomplished in the Master Diagonometer and in the Model 91 Analyzer by means of a unique dialing system—external test leads or connectors are not required. You dial your circuits like you dial a telephone.



With Supreme testing equipment bought at today's prices, you can forestall the higher markets that the rising costs of material and production are bringing closer and closer. There is no substitute for Supreme standards in instrument construction or in your daily service calls. Ask your Jobber for a demonstration. Meanwhile, inform yourself in detail of the latest progress in the science of radio servicing by sending for the FREE 1934 Catalog.

SUPREME INSTRUMENTS CORPORATION

481 Supreme Bldg.

Greenwood, Mississippi

I saved 1/2 by buying direct from the Midwest Laboratories

Yes, and it gives you WORLD-WIDE Reception!

Amazing New SUPER Deluxe

16-TUBE ALL-WAVE Radio

9 TO 2,000 METERS

30 DAYS FREE TRIAL



WRITE FOR NEW FREE CATALOG



BEFORE you buy any radio, write for this big new FREE Midwest catalog... printed in four colors. It has helped thousands of satisfied customers save from 1/4 to 1/2 on their radios... by buying direct from the Midwest Laboratories. You, too, can make a positive saving of 30% to 50% by buying a Midwest 16-tube deluxe ALL-WAVE radio at sensationally low direct-from-laboratory prices. You'll be amazed and delighted with its super performance! Broadcasts from stations 10,000 miles and more away are brought in... "clear as locals". You get complete wave length coverage of 9 to 2,000 meters (33 megacycles to 150 KC). Now, you can enjoy the new DX-ing hobby... and secure verifications from world's most distant stations.

These bigger, better, more powerful, clearer-toned, super-selective radios have FIVE distinct wave bands: ultra-short, short, medium, broadcast and long... putting the whole world of radio at your finger tips. Now listen in on all U. S. programs... Canadian, police, amateur, commercial, airplane and ship broadcasts... and programs from the four corners of the earth. Thrill to the chimes of Big Ben from GSB, at Daventry, England—tune in on the "Marseillaise" from FYA, Pointoise, France—hear sparkling music from EAQ, Madrid, Spain—listen to the call of the Kookaburra bird from VK2ME, Sydney, Australia—etc. Never before so much radio for so little money! Write for FREE catalog.

WORLD'S GREATEST RADIO VALUE

\$49.50

with New **Deluxe Auditorium Type SPEAKER**

... 40 NEW 1934 FEATURES ...

Try this Midwest radio... in your own home... for thirty days before you decide. See for yourself the 40 new 1934 features that insure amazing performance. Other features include: Automatic Select-O-Band, Amplified Automatic Volume Control, 16 New Type Tubes, Balanced Unit Superheterodyne Circuit, Velvety Action Tuning, Super-Power Class "A" Amplifier, 29 Tuned Circuits, New Duplex-Diode-High Mu Pentode Tubes, No-Image Heterodynes, Full Rubber Floated Chassis, Variable Tone Blender, Centralized Tuning, 7 KC Selectivity, New Thermionic Rectifier, Automatic Tone Compensation, Auditorium Type Speaker, etc. These features are usually found only in sets selling from \$100 to \$150.

AMAZING FOREIGN RECEPTION

AKRON, Ohio—My Midwest-16 is a real getter for distance. Received 205 stations on regular wave band... including U. S., Canadian, Mexican, Cuban and Hawaiian stations. Also many police, airport and "ham" stations from all over the country. Have logged London, France, Germany, Madrid, Rome, on 15-30 meter band. South American stations include Venezuela, Colombia, Brazil, Yucatan—L.H. MOELLER, 703 N. South St.

DEAL DIRECT WITH LABORATORIES

Increasing costs are sure to result in higher radio prices soon. Buy before the big advance... NOW, while you can take advantage of Midwest's amazing low prices. No middlemen's profits to pay! You save from 30% to 50% when you buy direct from Midwest Laboratories... you get 30 days FREE trial—as little as \$5.00 down puts a Midwest radio in your home. Satisfaction guaranteed or your money back! FREE catalog shows sensational radio values. Write TODAY!

SAVE UP TO 50%

TERMS AS LOW AS \$5.00 DOWN

NEW STYLE CONSOLES

Write quickly for your FREE copy of the new Midwest catalog. It pictures a complete line of beautiful, artistic deluxe consoles and chassis... in four colors! Sensational low prices save you 30% to 50%. Also shows performance curves that prove Midwest radios out-perform most of the \$150 sets. You can order your Midwest radio from this catalog with as much certainty of satisfaction as if you were to select it personally at our great radio laboratories. Write TODAY!

MAIL COUPON TODAY! FOR AMAZING 30-DAY FREE TRIAL OFFER AND NEW 1934 CATALOG

MIDWEST RADIO CORP.
Dept. 380
Cincinnati, Ohio.

Without obligation on my part send me your new FREE 1934 catalog, and complete details of your liberal 30-day FREE trial offer. This is NOT an order.

AGENTS! Make Easy Extra Money
Check Here for Details

Name.....
Address.....
City..... State.....

MIDWEST RADIO CORP.
DEPT. 380 — CINCINNATI, OHIO, U. S. A.
Established 1920 Cable Address Miraco ABC 5th Edition